

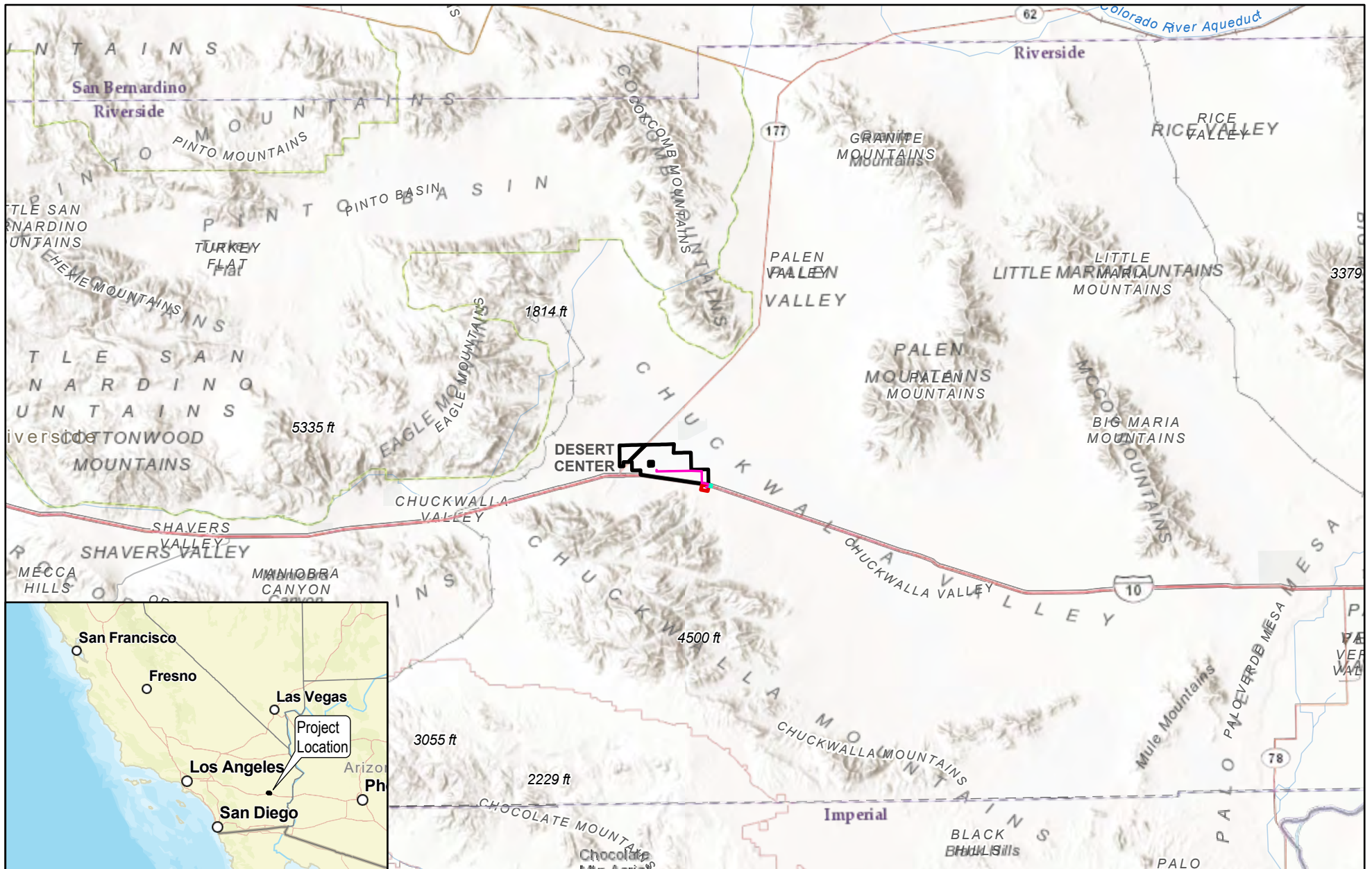



# Appendix B

Figures



-  Proposed Solar Facility
-  Existing SCE Red Bluff Substation
-  Proposed 500-kV Gen-tie Line Corridor
-  500-kV Gen-tie Line Corridor Option (based on final negotiations with SCE and ROW holders)

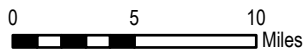
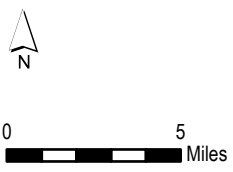
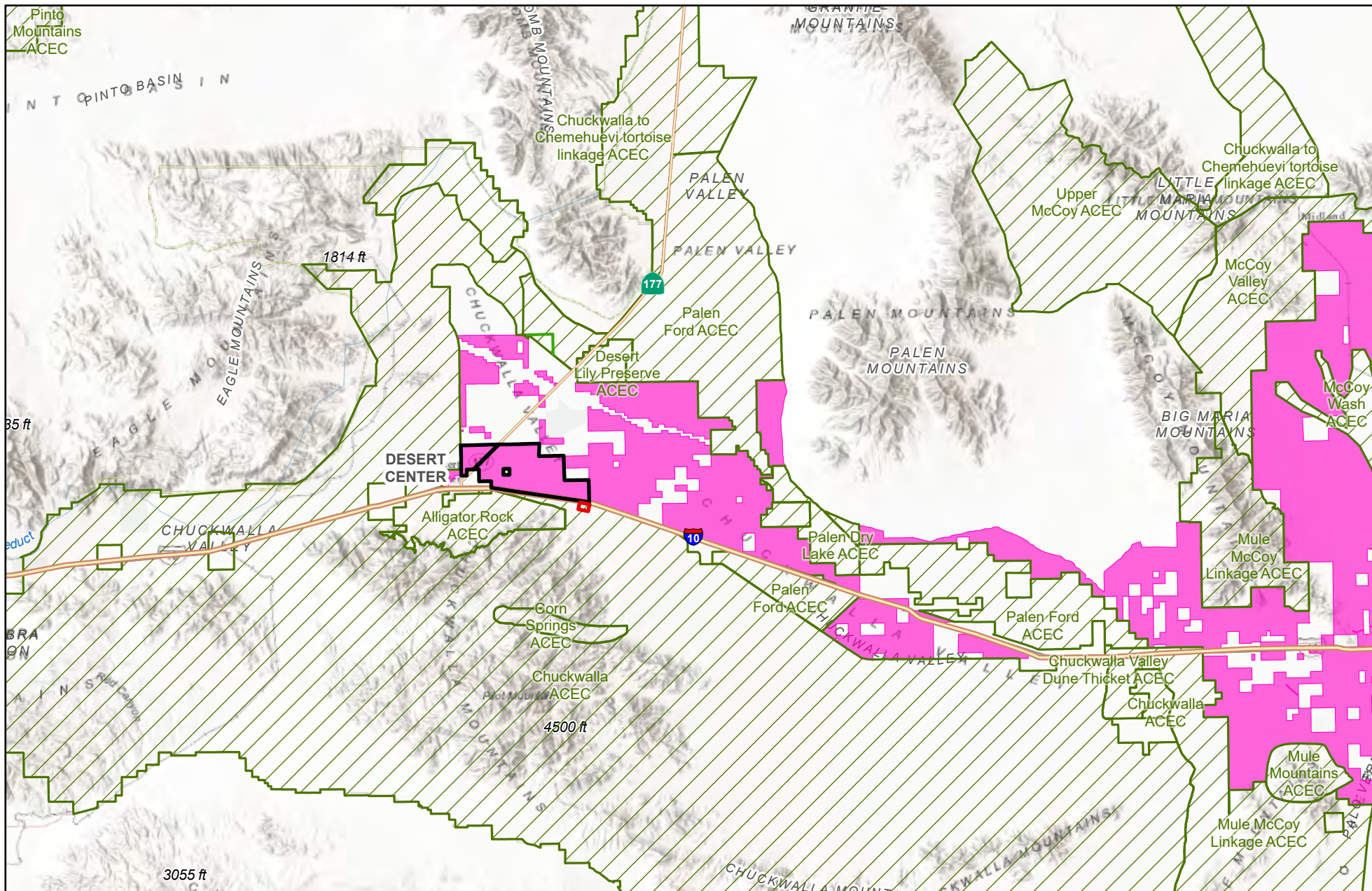

Figure 1-1

Project Vicinity





- Project Area
- Existing SCE Red Bluff Substation
- Development Focus Areas (DFA)
- Area of Critical Environmental Concern (ACEC)\*

\*ACEC protections only apply on BLM lands.

Figure 1-2



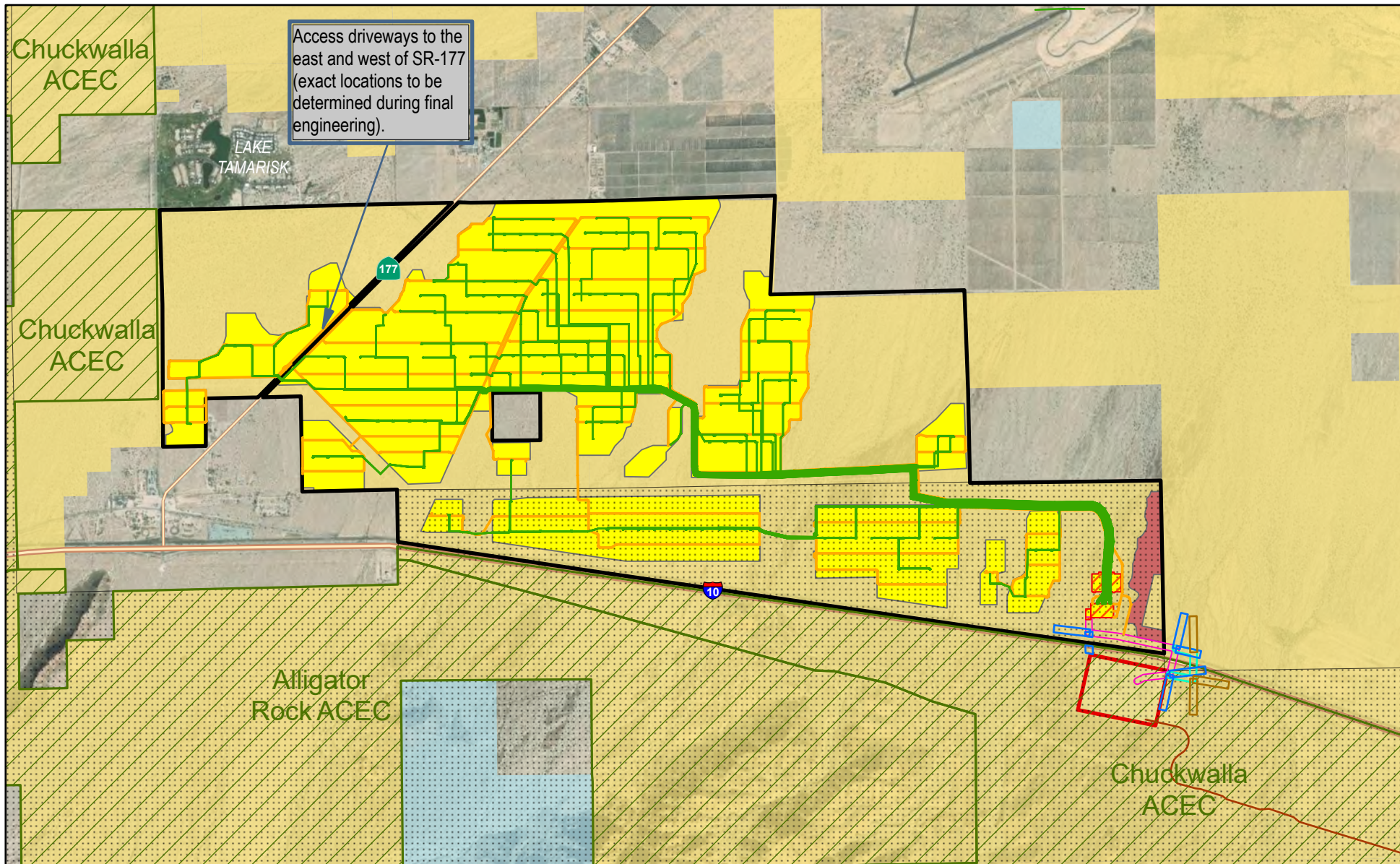

Access driveways to the east and west of SR-177 (exact locations to be determined during final engineering).

- Project Boundary
- Fenced Solar Array
- Substation and BESS Area
- 500-kV Gen-tie Line Corridor
- 500-kV Gen-tie Line Corridor Option
- Pull Tensioning Area
- Optional Pull Tensioning Area
- 34.5-kV Collector Lines
- Roads
- Gen-tie Access Road
- Eagle Crest Gen-tie Line ROW
- Existing SCE Red Bluff Substation
- Area of Critical Environmental Concern
- Desert Tortoise Critical Habitat

- Land Ownership
- Bureau of Land Management
  - State

**Figure 2-1**

**Oberon Renewable Energy Project Area**



Sources: Aspen, 2021; Intersect Power, 2021; Mortenson, 2021; BLM, 2021; Esri, 2021.



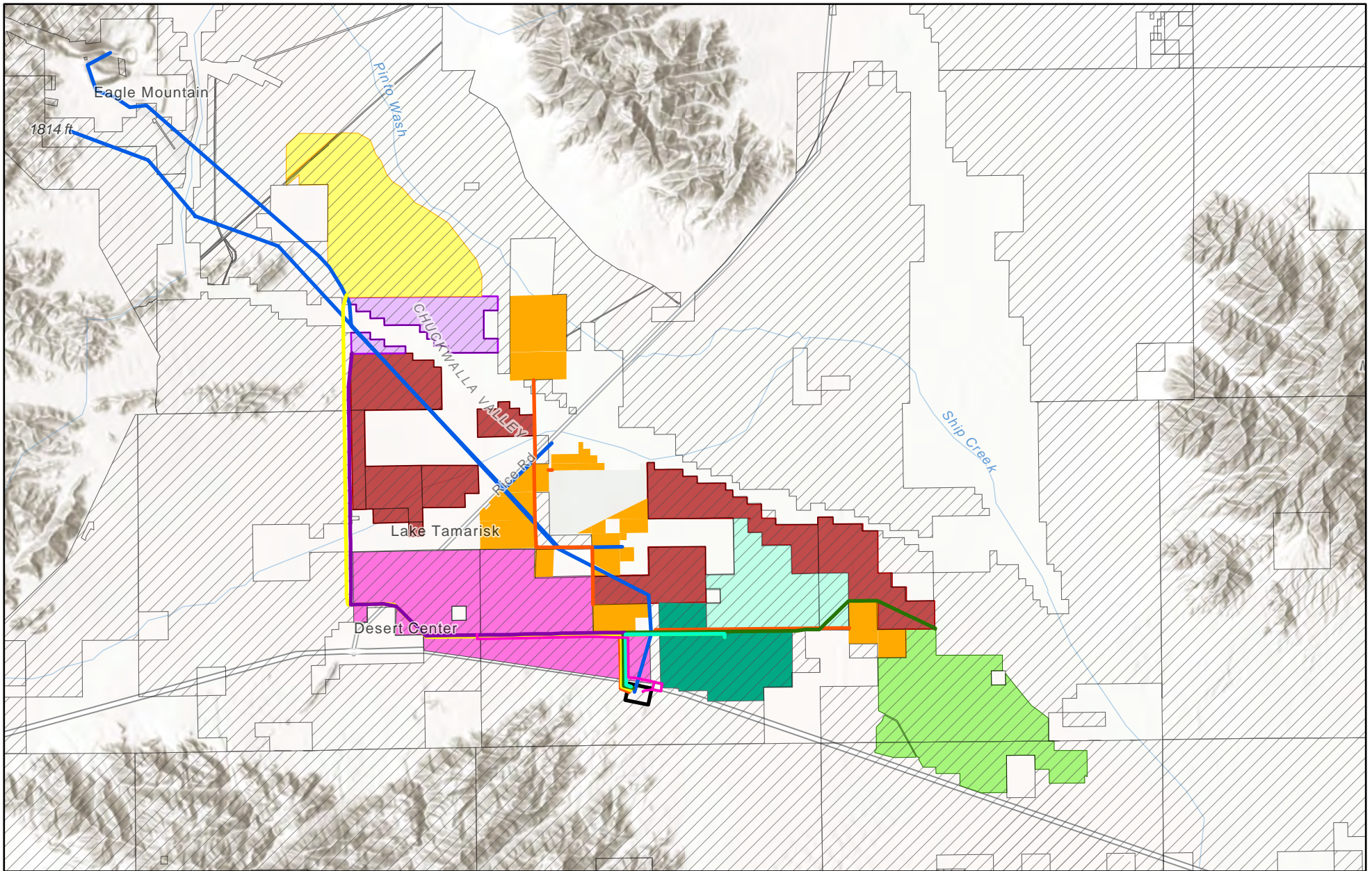

Desert Center Solar Project Sites and Gen-Tie Lines

- |  |                                     |   |   |
|--|-------------------------------------|---|---|
|  | SCE Red Bluff Substation (Existing) | Oberon Renewable Energy Project (Proposed)          | Clearway Arica (Proposed)                               |
|  | BLM-Administered Land               | Athos Renewable Energy Project (Under Construction) | Clearway Victory Pass (Proposed)                        |
|  | Desert Harvest (Existing)           | Easley Project (Proposed)                           | Eagle Crest Energy Gen-tie Line and Pipeline (Approved) |
|  | Desert Sunlight (Existing)          |   |   |
|  | Palen Solar PV Project (Existing)   |   |   |

Figure 2-2

Desert Center Solar Projects

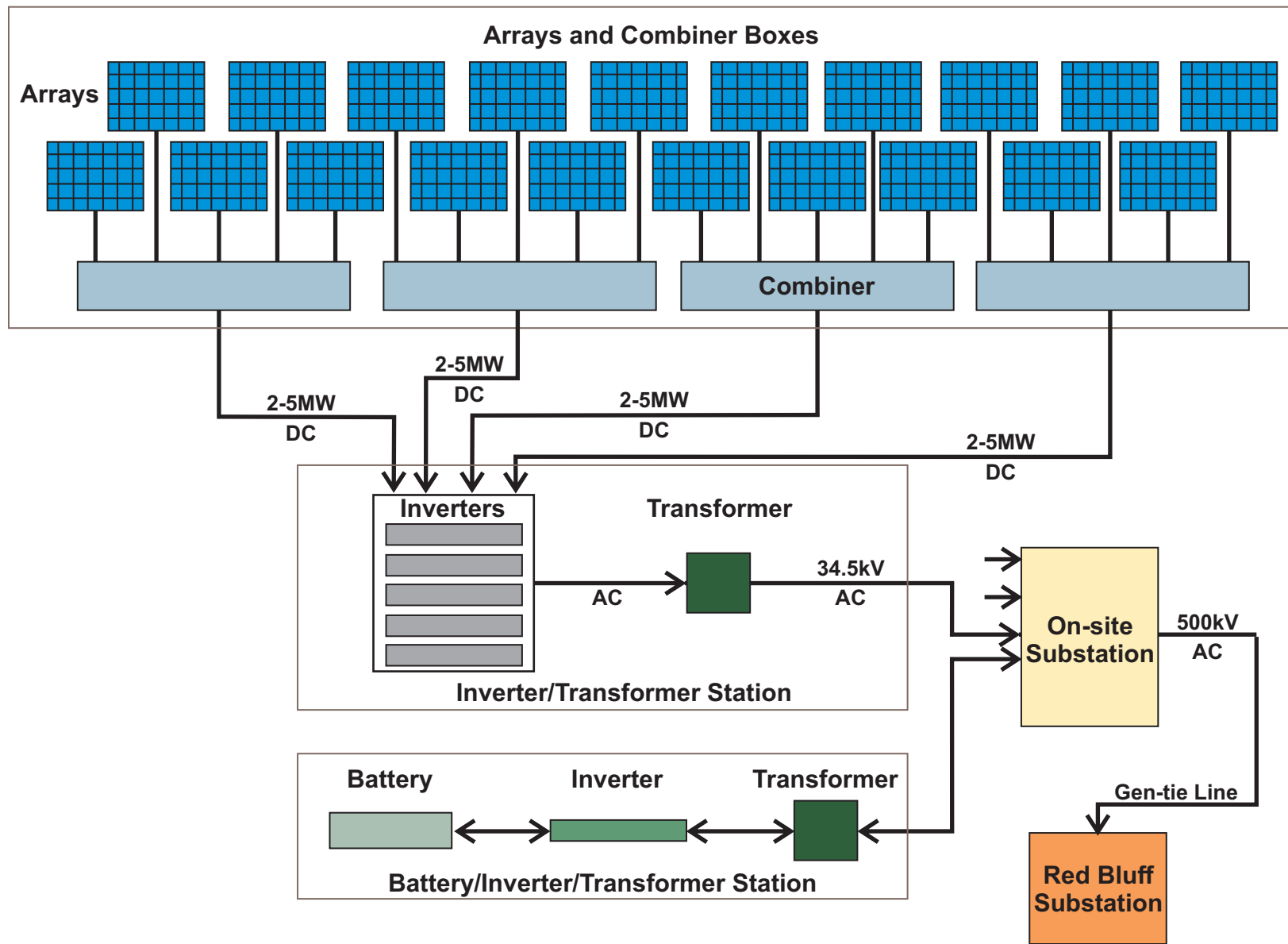
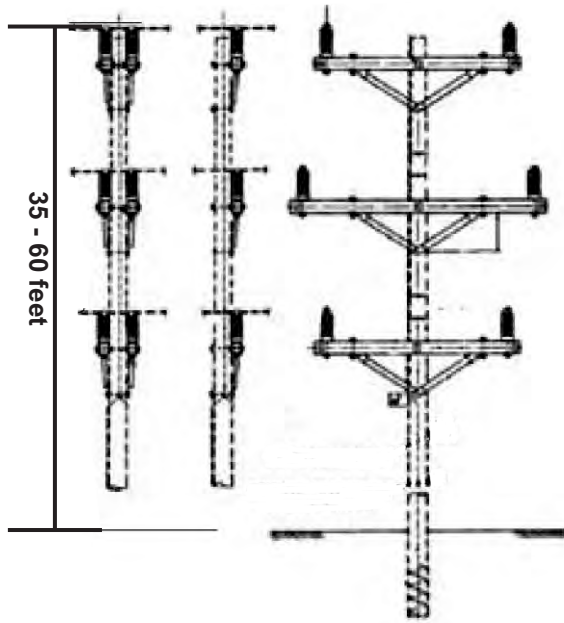

Figure 2-3

Solar PV and BESS Power Flow Diagram





Double Circuit 34.5 kV  
Overhead Line Wood Pole

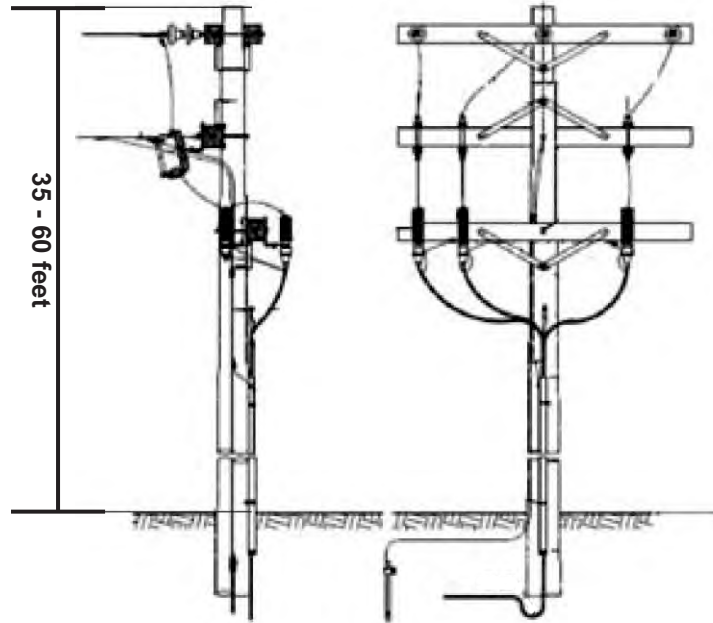

Riser Wood Pole

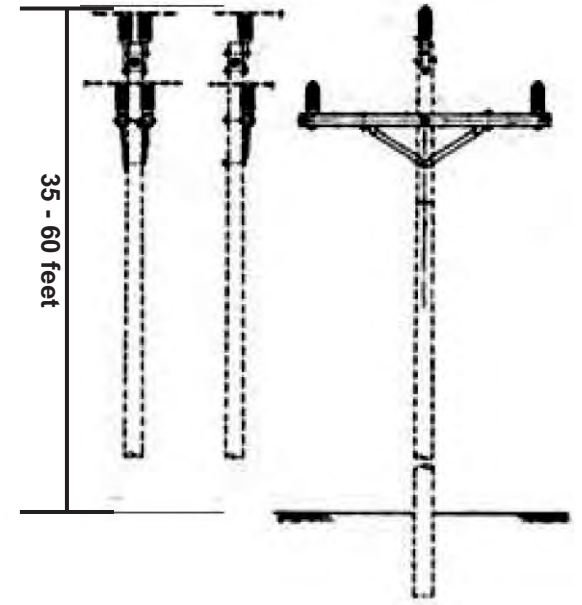

Single Circuit 34.5 kV  
Overhead Line Wood Pole

Figure 2-4

Typical 34.5 kV Medium Voltage Line Structures

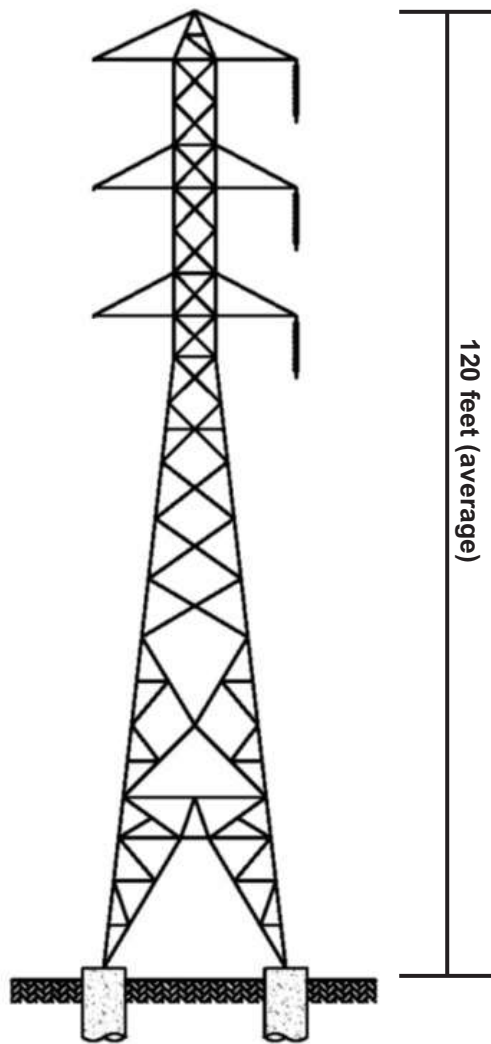

*Typical 500 kV Single-Circuit Lattice Tower*

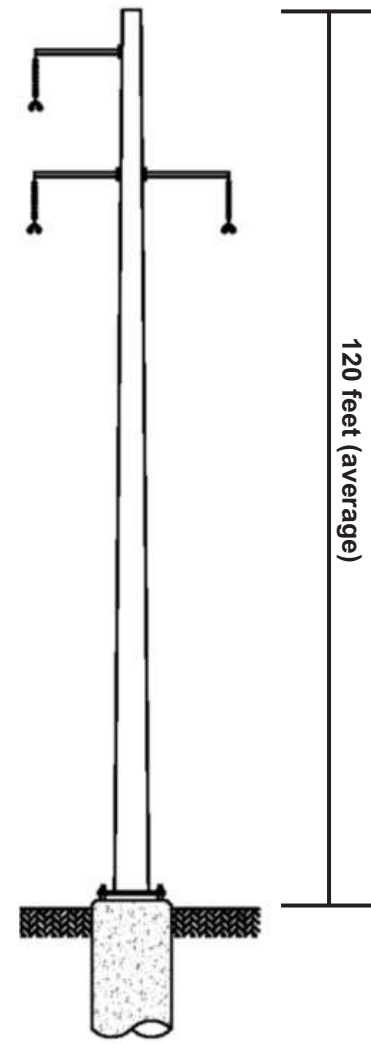

*Typical 500 kV Single-Circuit Monopole*

Figure 2-5

Typical 500 kV Gen-Tie Line Structures



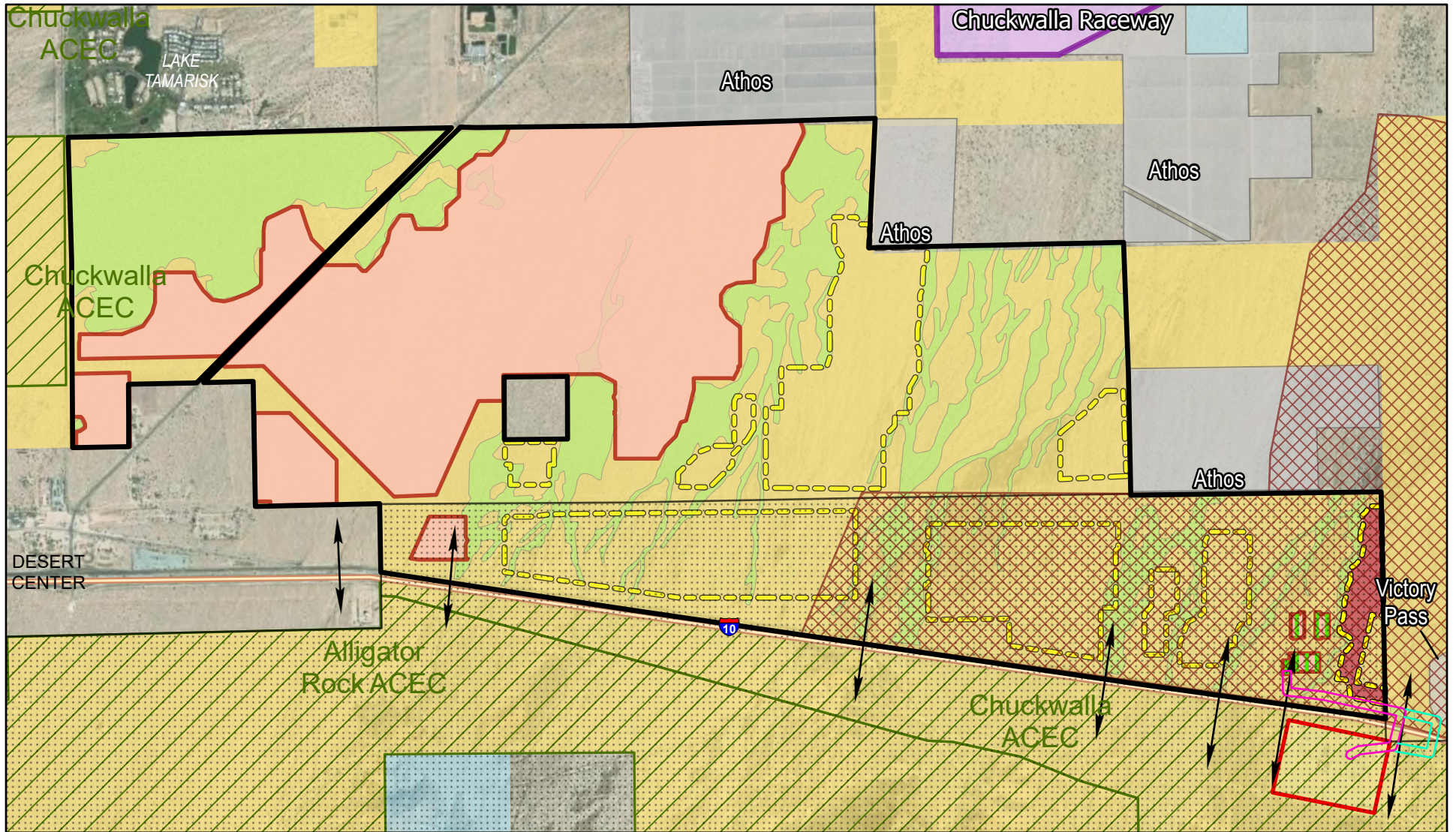

	Project Area	Proposed 500-kV Gen-Tie Line Corridor	Multispecies Linkage
	Adjacent Desert Center Solar Projects	500-kV Gen-tie Option (based on final negotiations with SCE and ROW holders)	Freeway, aqueduct, and railway underpasses
	Eagle Crest Gen-tie Line (Desert Tortoise Pass Fencing)	Existing SCE Red Bluff Substation	Chuckwalla Raceway
	Desert Tortoise Exclusion Fencing	Desert Dry Wash Woodland	<b>Land Ownership</b>
Desert Tortoise Pass Fencing	Desert Tortoise Critical Habitat	Bureau of Land Management	State
Substation/BESS Area (Desert Tortoise Exclusion Fencing)	Area of Critical Environmental Concern (ACEC)		

**Figure 2-6  
Fencing Plan**

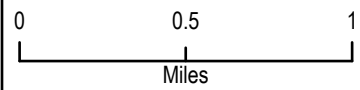



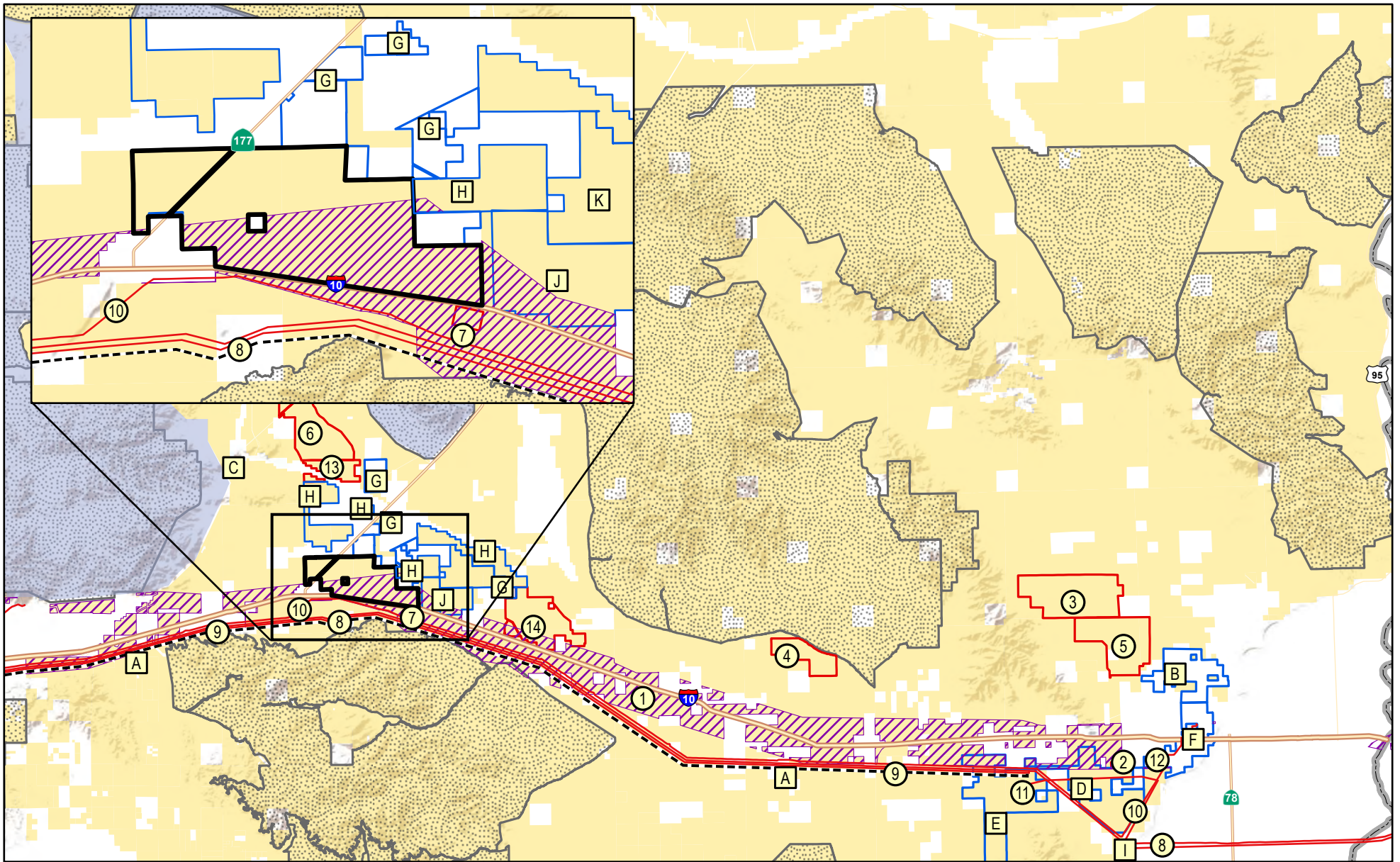

\*Refer to tables 3.1-1 and 3.1-2 for information on Existing and Foreseeable Projects.

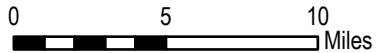

**Existing Projects\***



**Foreseeable Projects\***



**Proposed Project Area**

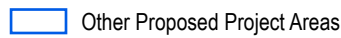

**Other Proposed Project Areas**



**DRECP Development Focus Areas**



**Bureau of Land Management Land**



**Section 368 Energy Corridors**

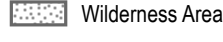

**Wilderness Area**



**Figure 3.1-1**

**Cumulative Projects**



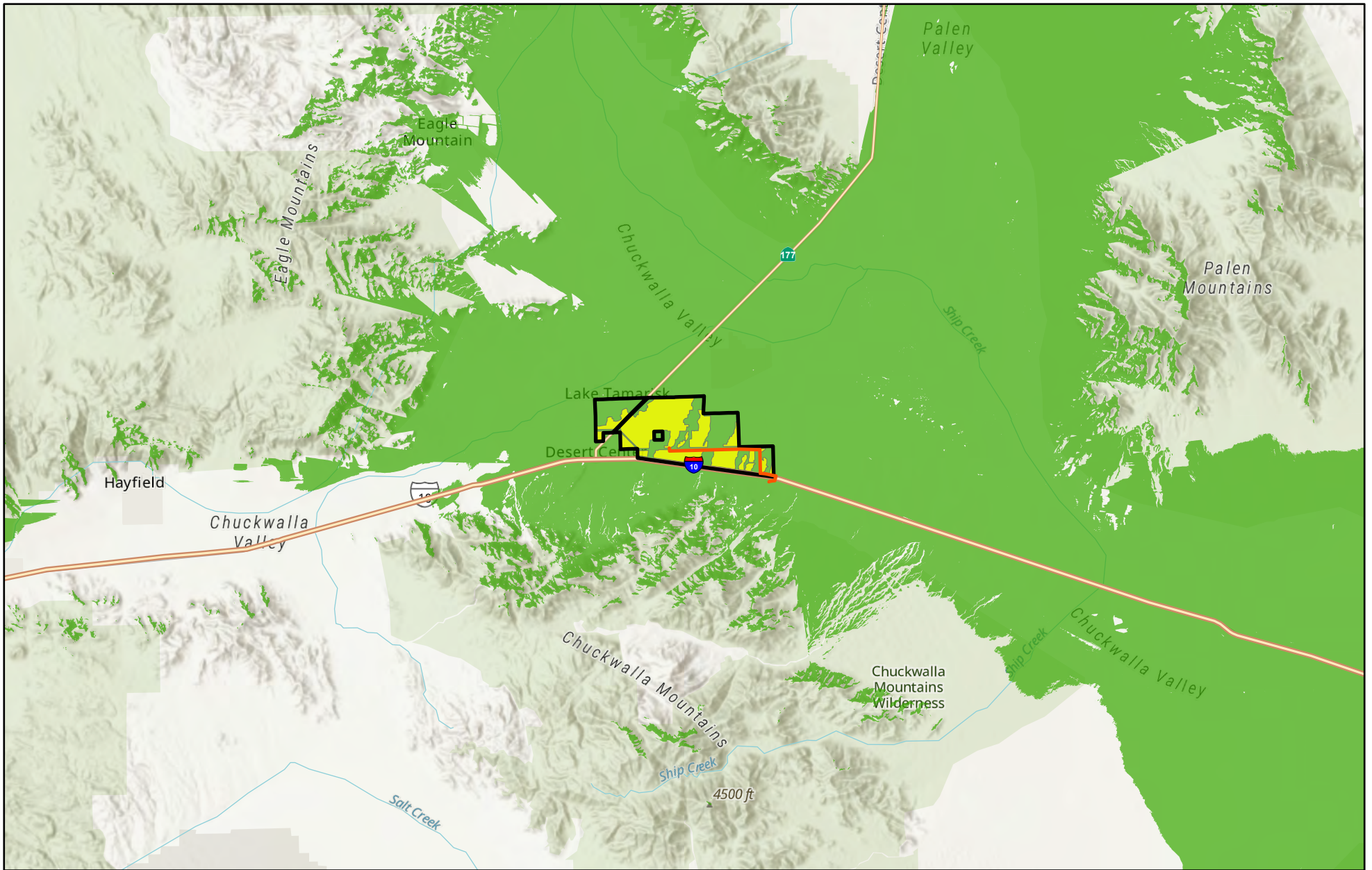

0 5 Miles

- Oberon Gen-Tie Line Corridor
- Fenced Solar Array
- Fenced Solar Array or Gen-Tie Line Visible

**Figure 3.2-1A**

**Oberon Renewable Energy Project  
Viewshed**



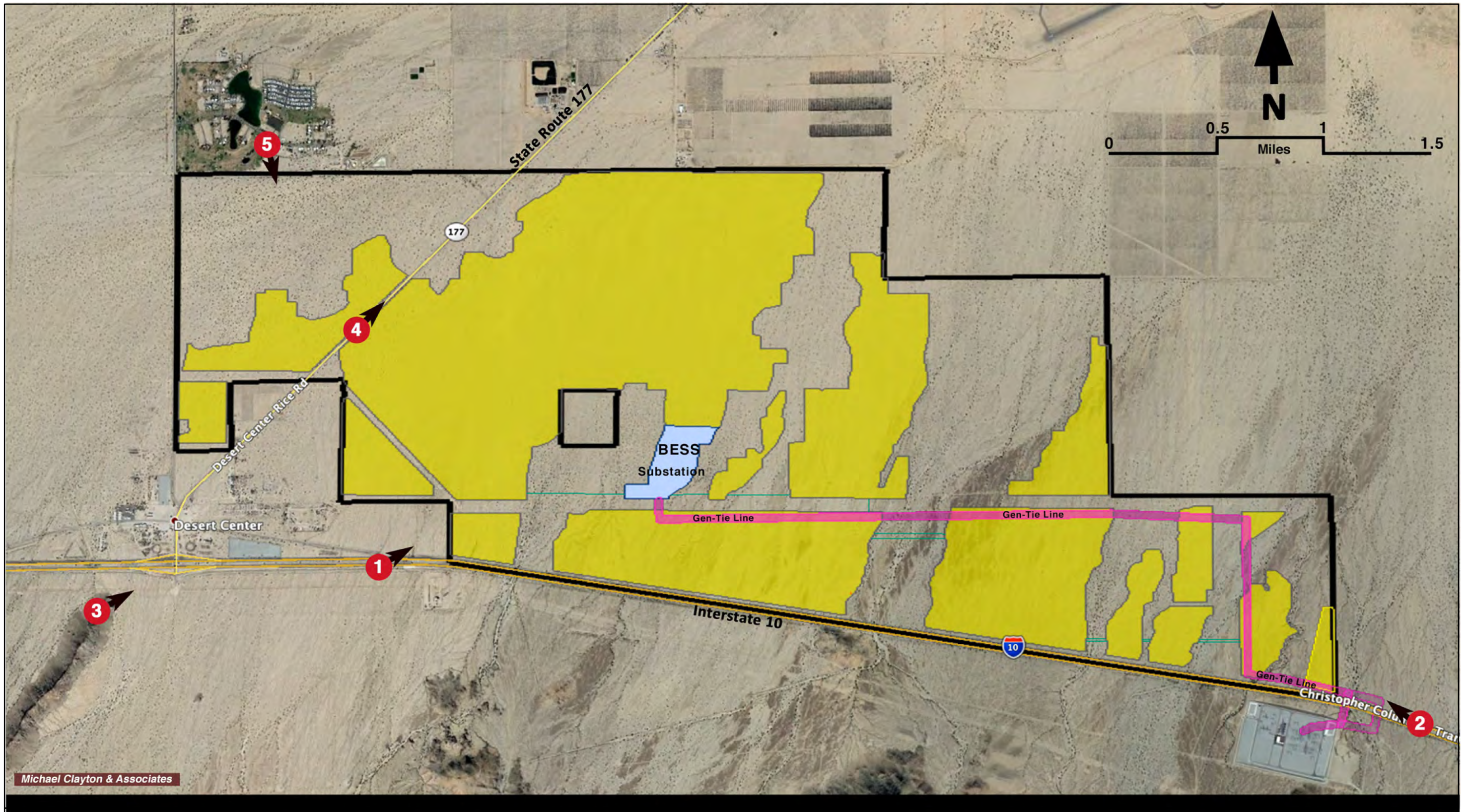

**LEGEND**

- Project Solar Fields
- Project Boundary

2  Key Observation Point (KOP)

Figure 3.2-1B

KOP Map





Michael Clayton & Associates

Latitude: 33.710380° Longitude: -115.384281°

This image presents the **Existing View** to the northeast from **KOP 1** on eastbound I-10, approximately 0.9 mile east of the Desert Center Rice Road (SR 177) overpass. This view captures a central portion of Chuckwalla Valley and the Project area east of SR-177 and north of I-10. This expansive view of the valley is backdropped by the rugged, angular forms of the Coxcomb, Granite, and Palen Mountains, features that contribute visual interest though are partially obscured by smoke from regional wild fires.

Figure 3.2-2A  
KOP 1 Eastbound Interstate 10  
Existing View





Michael Clayton & Associates

Latitude: 33.710380° Longitude: -115.384281°

This image presents a **Visual Simulation** of the proposed Project from **KOP 1** on eastbound I-10, approximately 0.9 mile east of the Desert Center Rice Road (SR 177) overpass. From KOP 1, the closest viewing distance to the nearest arrays would be approximately 0.35 mile. In addition to the solar arrays, the upper portion of the substation and the first gen-tie structure would be visible near the right edge of the image above. The BESS facilities would be screened from view by intervening arrays.

Figure 3.2-2B  
KOP 1 Eastbound Interstate 10  
Visual Simulation





Michael Clayton & Associates

Latitude: 33.700022° Longitude: -115.302203°

This image presents the **Existing View** to the west from **KOP 2** on westbound I-10, just east of the proposed gen-tie span of I-10 and approximately 3.6 miles west of the Corn Springs Road overpass. This view captures a central portion of Chuckwalla Valley north and east of Desert Center and provides an expansive view of the valley, backdropped by the rugged, horizontal to angular form of the Eagle Mountains, features that contribute visual interest (partially obscured by smoke from regional wild fires).

Figure 3.2-3A  
KOP 2 Westbound Interstate 10  
Existing View





Michael Clayton & Associates

Latitude: 33.700022° Longitude: -115.302203°

This image presents a **Visual Simulation** of the proposed Project from **KOP 2** on westbound I-10, just east of the proposed gen-tie span of I-10 and approximately 3.6 miles west of the Corn Springs Road overpass. This view captures the eastern portion of the Project, though the arrays are substantially screened by intervening vegetation. Most prominent is the gen-tie line extending to the east from the substation in the central portion of the Project, to the close parallel with I-10 and subsequent span of the freeway.

Figure 3.2-3B  
KOP 2 Westbound Interstate 10  
Visual Simulation





Michael Clayton & Associates

Latitude: 33.707365° Longitude: -115.406226°

This image presents the **Existing View** to the northeast from **KOP 3** on the crest of Alligator Rock, just south of I-10 and Desert Center. This view overlooks the eastern portion of Desert Center and a central portion of Chuckwalla Valley east of SR 177 (at the left side of the image above) and north of I-10 (extending diagonally through the center of the image). This expansive view of the valley is backdropped by the horizontal to angular forms of the Granite and Palen Mountains, features that contribute visual interest.

Figure 3.2-4A  
KOP 3 Alligator Rock  
Existing View





Michael Clayton & Associates

Latitude: 33.707365° Longitude: -115.406226°

This image presents a **Visual Simulation** of the proposed Project as viewed from **KOP 3** on the crest of Alligator Rock, just south of I-10 and Desert Center. This frame of view encompasses the central portion of the proposed Project's solar arrays, at viewing distances ranging from approximately 1.2 miles (closest to KOP 3) to approximately five miles. The substation, BESS, and gen-tie line are visible in the center-right portion of the image.

Figure 3.2-4B  
KOP 3 Alligator Rock  
Visual Simulation





Michael Clayton & Associates

Latitude: 33.725968° Longitude: -115.386115°

This image presents the **Existing View** to the north from **KOP 4** on northbound SR 177 (Rice Road), approximately 1.2 miles northeast of Desert Center. This view up SR 177 captures a central portion of the Chuckwalla Valley in the immediate vicinity of SR 177. This expansive view of the broad, flat valley floor is backdropped by the horizontal to angular forms of the Coxcomb, Granite, and Palen Mountains, features that contribute visual interest, though in the image, are somewhat obscured by smoke from wild fires.

Figure 3.2-5A  
KOP 4 Northbound SR 177  
Existing View





Michael Clayton & Associates

Latitude: 33.725968° Longitude: -115.386115°

This image presents a **Visual Simulation** of the proposed Project from **KOP 4** on northbound SR 177 (Rice Road). This view encompasses a northwestern portion of the proposed solar arrays that would border both sides of SR 177. As is apparent in the simulation, the Project would appear as a prominent industrial facility in the immediate foreground of views from the road and assumes the retention of existing vegetation adjacent to the road to provide partial screening of the project facilities.

Figure 3.2-5B  
KOP 4 Northbound SR 177  
Visual Simulation





Michael Clayton & Associates

Latitude: 33.738153° Longitude: -115.393274°

This image presents the **Existing View** to the south-southeast from **KOP 5** on the Lake Tamarisk golf course. This view captures a portion of the relatively undeveloped Chuckwalla Valley, backdropped by the rugged, Chuckwalla Mountains. The landscape does host considerable infrastructure including utility lines, the gen-tie lines for the Desert Sunlight and Desert Harvest solar projects, a natural gas pump station, high-voltage electric transmission lines, I-10 with its associated vehicles, and a telecommunications tower.

Figure 3.2-6A

KOP 5 Lake Tamarisk Desert Resort  
Existing View





Michael Clayton & Associates

Latitude: 33.738153° Longitude: -115.393274°

This image presents a **Visual Simulation** of the proposed Project from **KOP 5** on the Lake Tamarisk golf course. This view encompasses a portion of the western-most solar arrays on the west side of SR 177. As is apparent in the simulation, the arrays would appear as a low, horizontal feature along the valley floor, and would be partially screened from view by intervening vegetation. The viewing distance to the arrays would range from approximately 0.65 mile to approximately two miles.

Figure 3.2-6B

KOP 5 Lake Tamarisk Desert Resort  
Visual Simulation



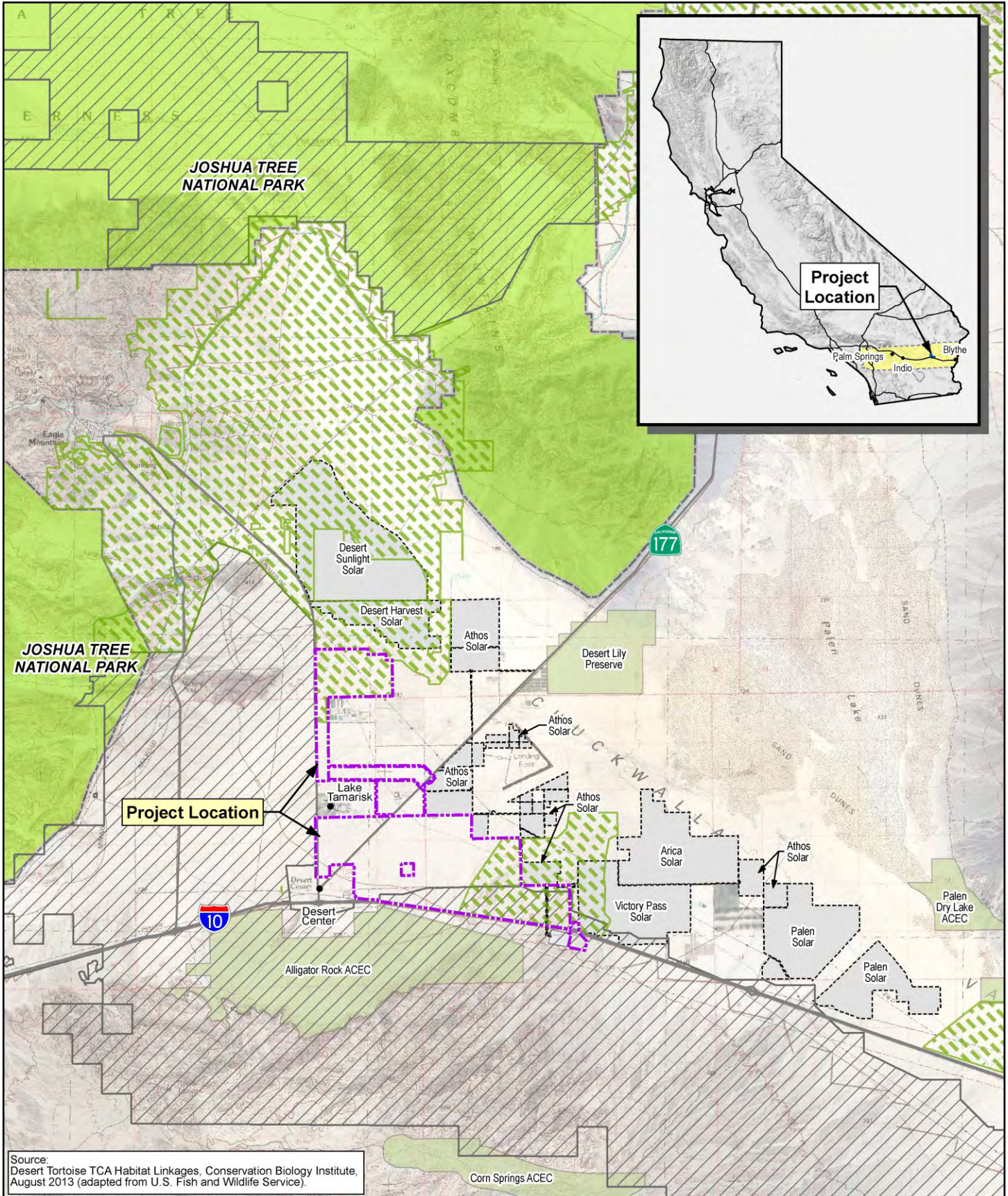

Source: Desert Tortoise TCA Habitat Linkages, Conservation Biology Institute, August 2013 (adapted from U.S. Fish and Wildlife Service).

Source: BRTR, 2021

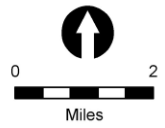

-  Oberon Study Area
-  Multi-Species Linkage Area
-  Desert Tortoise Critical Habitat
-  Area of Critical Environmental Concern (ACEC)
-  Joshua Tree National Park
-  Other Solar Generating Sites (developed and proposed)

**Figure 3.4-1**  
**Project Location**



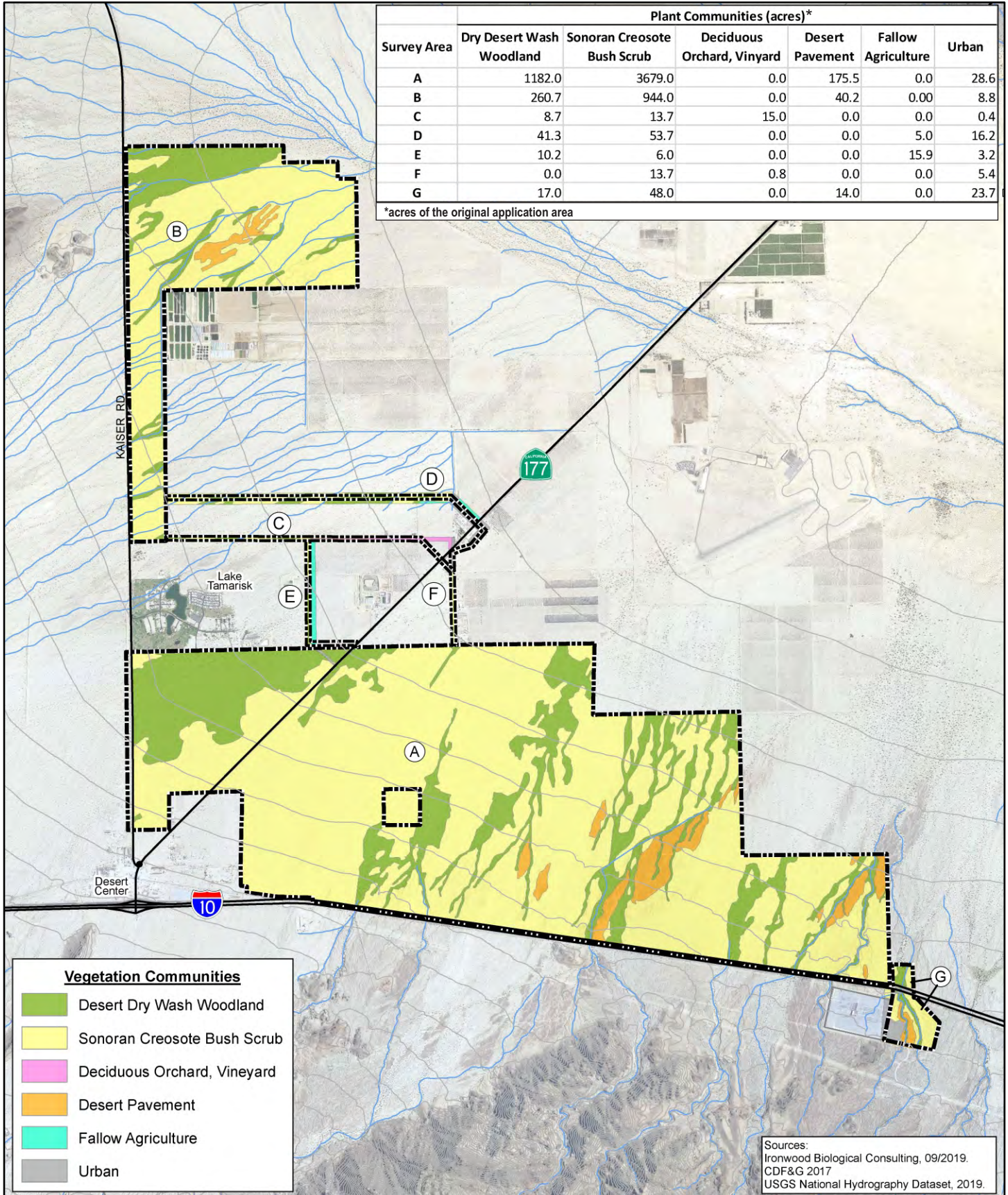

Source: BRTR, 2021

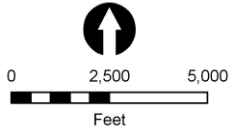

~ Ephemeral Drainage  
 [Dashed Box] Oberon Study Area

Sources:  
 Ironwood Biological Consulting, 09/2019.  
 CDF&G 2017  
 USGS National Hydrography Dataset, 2019.

**Figure 3.4-2**  
**Vegetation Communities**



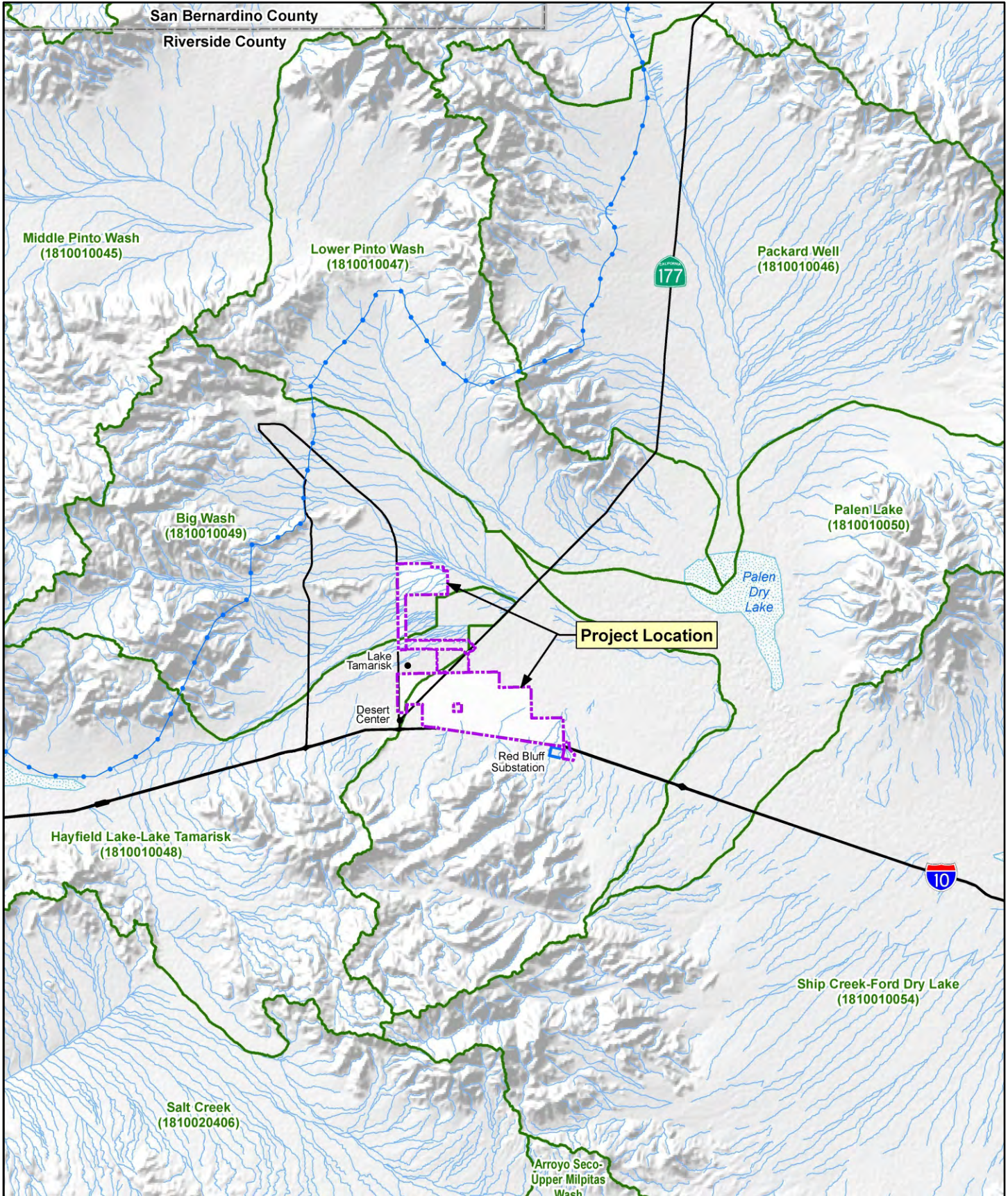

**Figure 3.4-3**  
**Drainages**



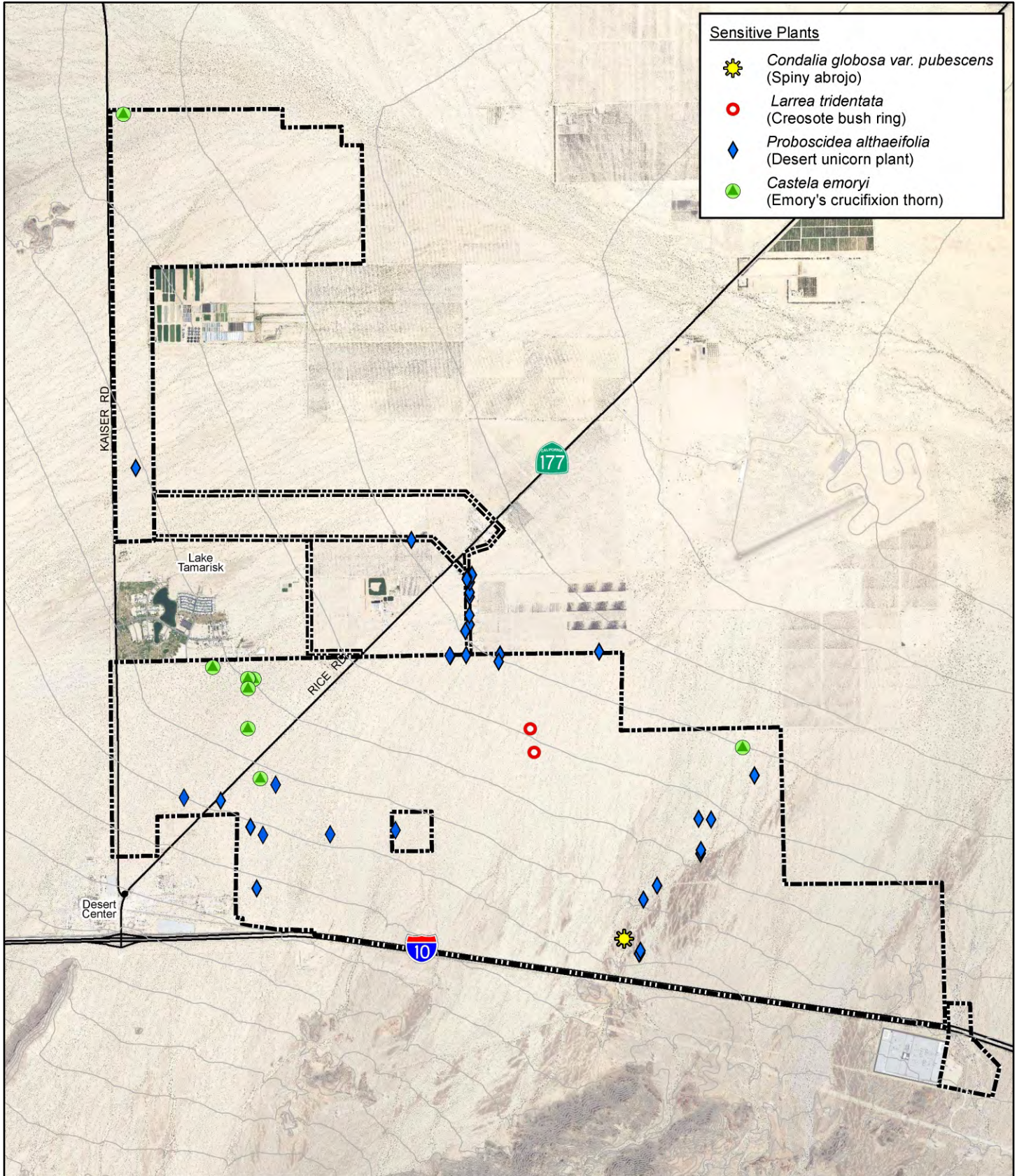

Source: BRTR, 2021

 Oberon Study Area

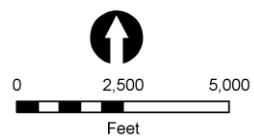
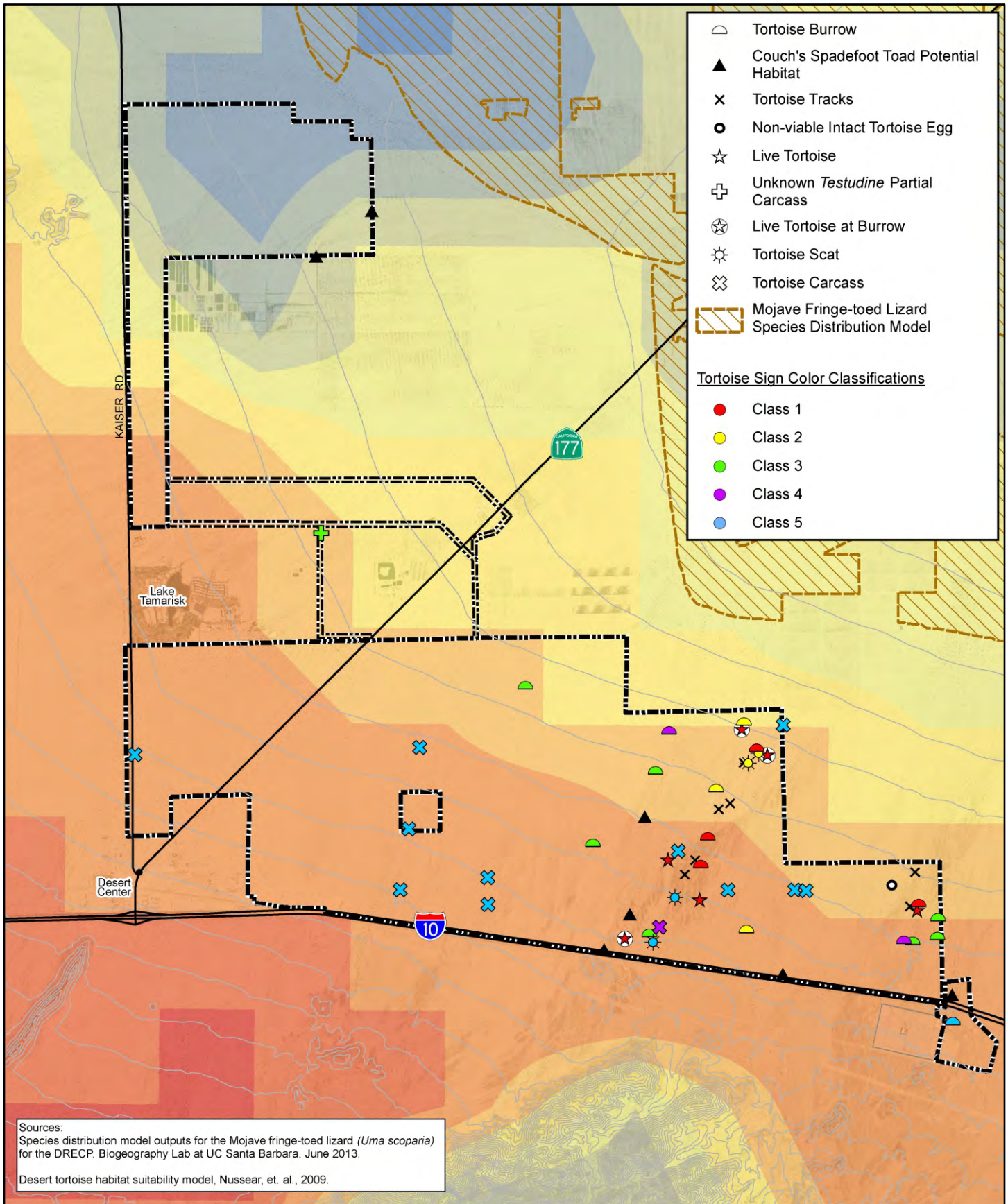

Figure 3.4-4

Special-status Plant Observations





Source: BRTR, 2021

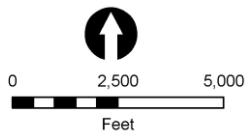

Oberon Study Area

**Predicted Desert Tortoise Occupancy**

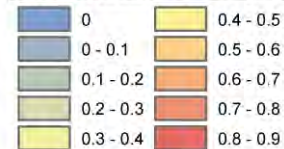

**Figure 3.4-5**

**Noteworthy Amphibian and Reptile Observations**



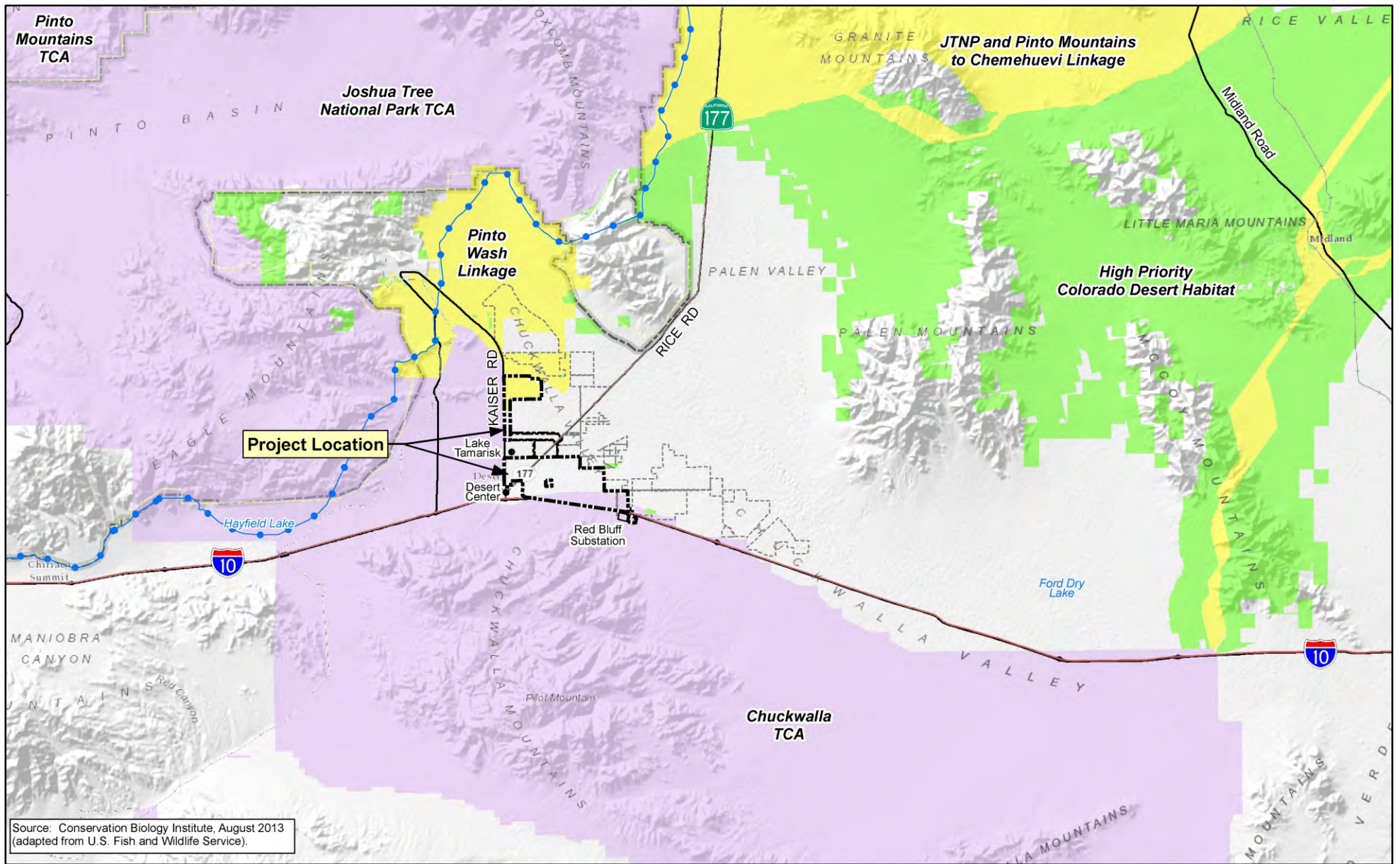

Source: BRTR, 2021

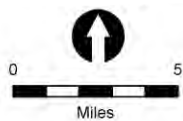
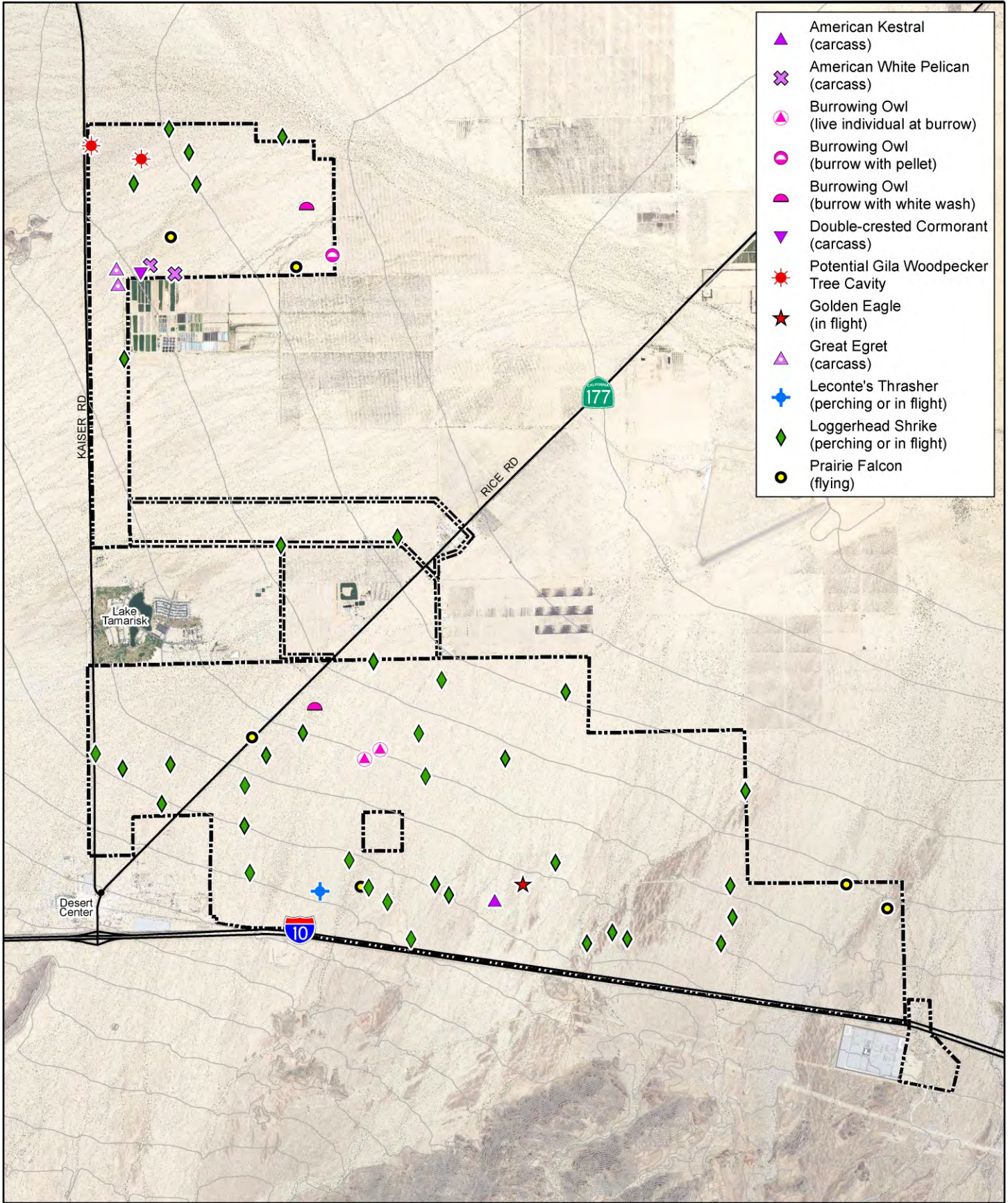

Figure 3.4-6

Desert Tortoise Conservation Areas (TCAs) and Linkages





- ▲ American Kestrel (carcass)
- ✕ American White Pelican (carcass)
- ▲ Burrowing Owl (live individual at burrow)
- Burrowing Owl (burrow with pellet)
- ◐ Burrowing Owl (burrow with white wash)
- ▼ Double-crested Cormorant (carcass)
- ☀ Potential Gila Woodpecker Tree Cavity
- ★ Golden Eagle (in flight)
- ▲ Great Egret (carcass)
- ✚ Leconte's Thrasher (perching or in flight)
- ◆ Loggerhead Shrike (perching or in flight)
- Prairie Falcon (flying)

Source: BRTR, 2021

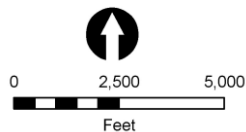

▭ Oberon Study Area

Figure 3.4-7

Noteworthy Avian Observations



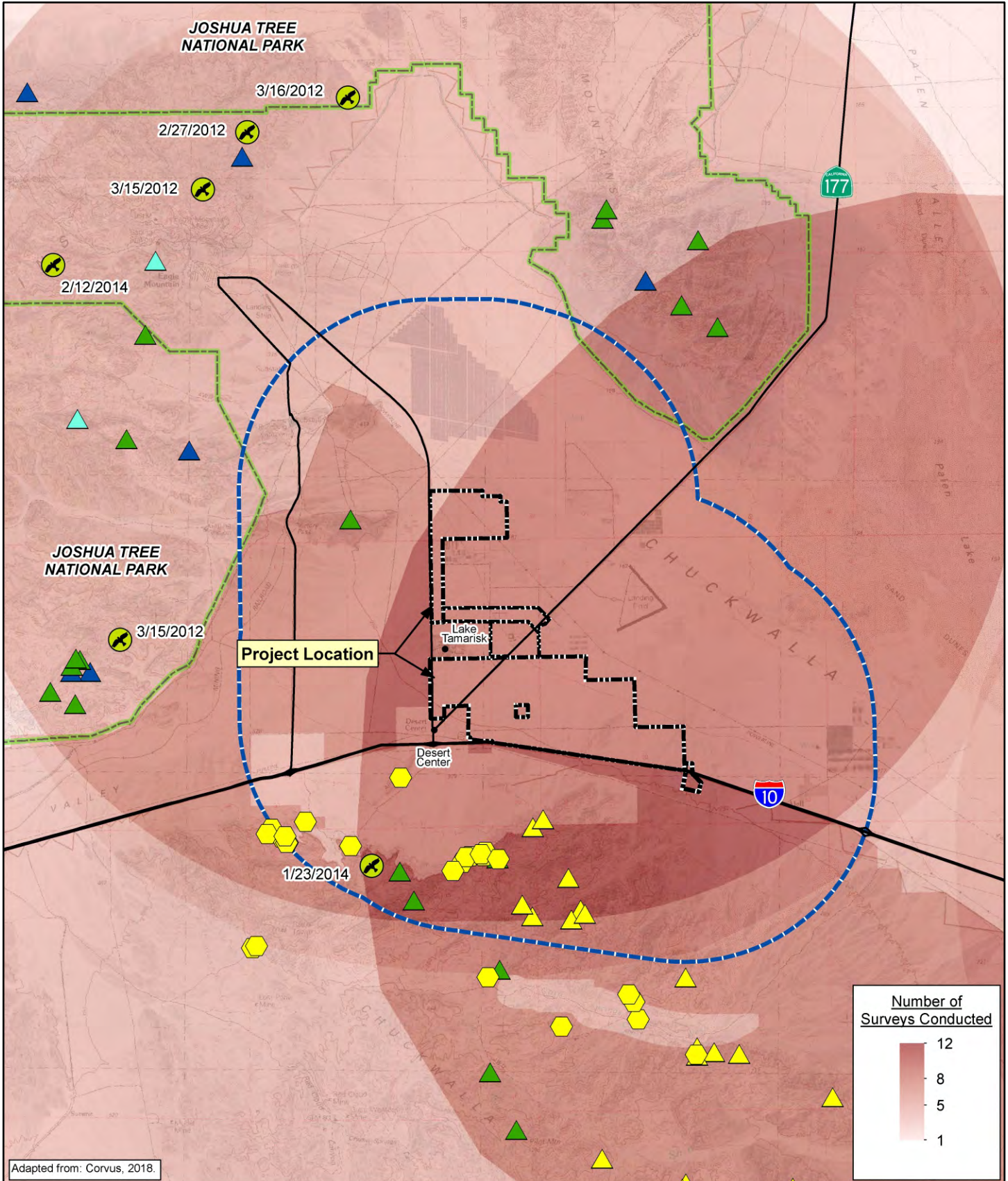

Adapted from: Corvus, 2018.

Source: BRTR, 2021

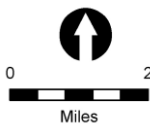

**Season Last Surveyed**

- ▲ 2009-2010
- ▲ 2011-2012
- ▲ 2013-2014
- ▲ 2014-2015

- ⬡ Cliff Nests Monitored During BLM Raven Surveys
- ⊗ GOEA Sighting (Date of Sighting)
- Oberon Study Area
- Oberon Study Area 4-mile Buffer
- Joshua Tree National Park

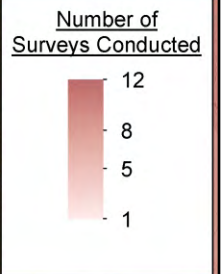

**Figure 3.4-8**

**Golden Eagle Survey Results 2010-2015**



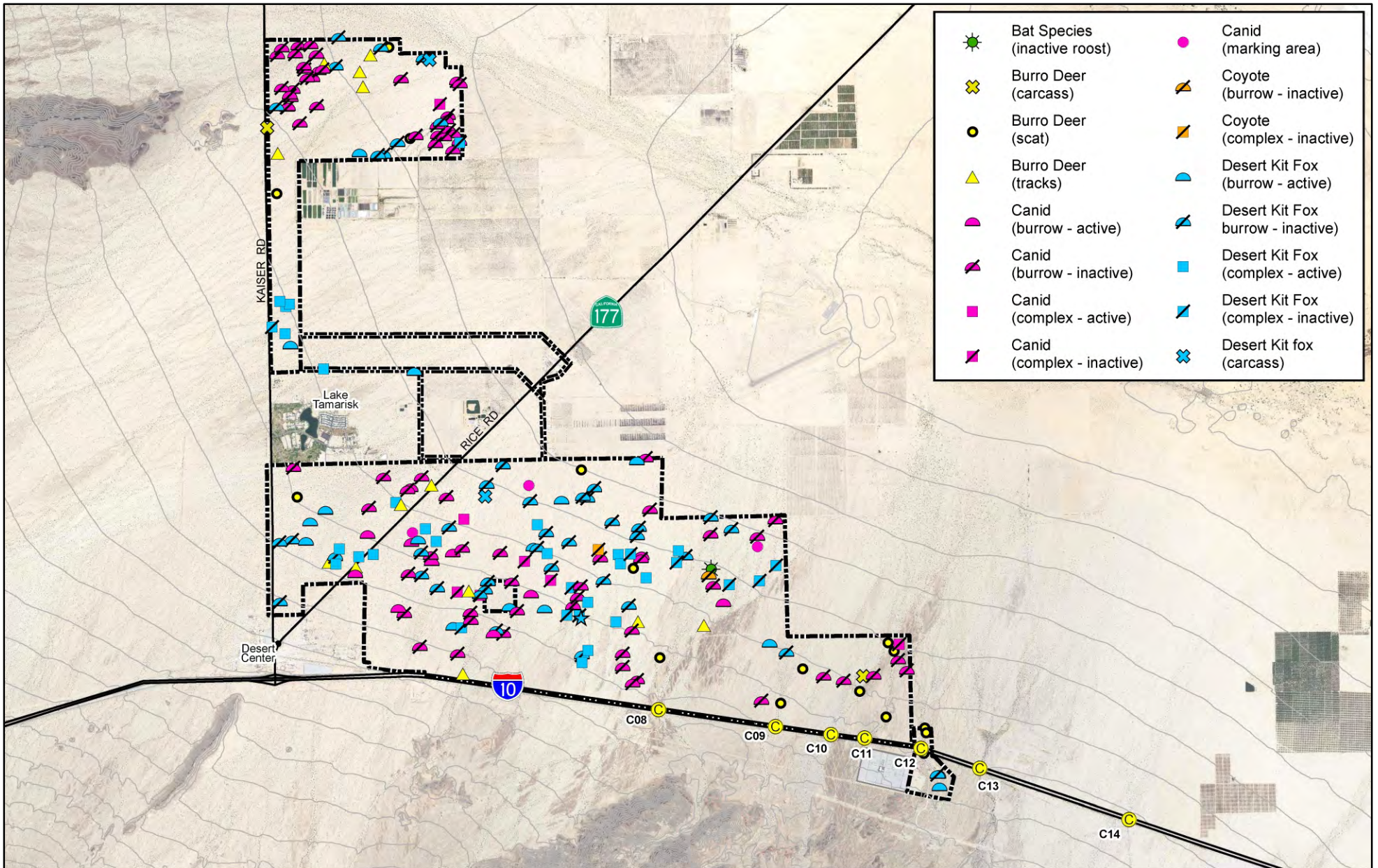

Source: BRTR, 2021

Camera Station

Oberon Study Area

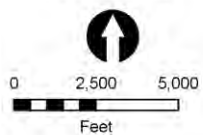
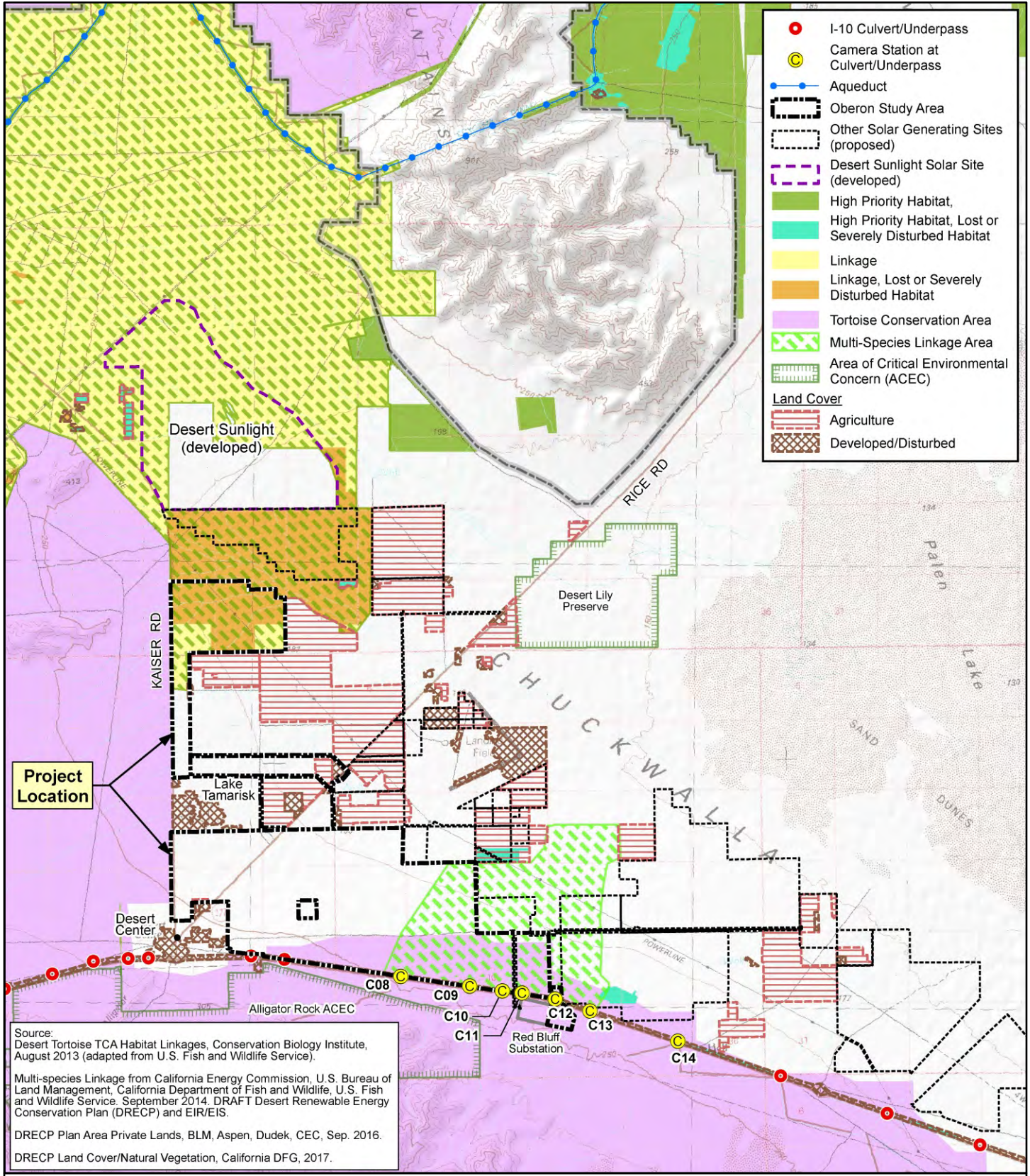

Figure 3.4-9

Noteworthy Mammal Observations





Source: BRTR, 2021

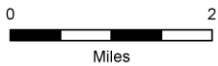
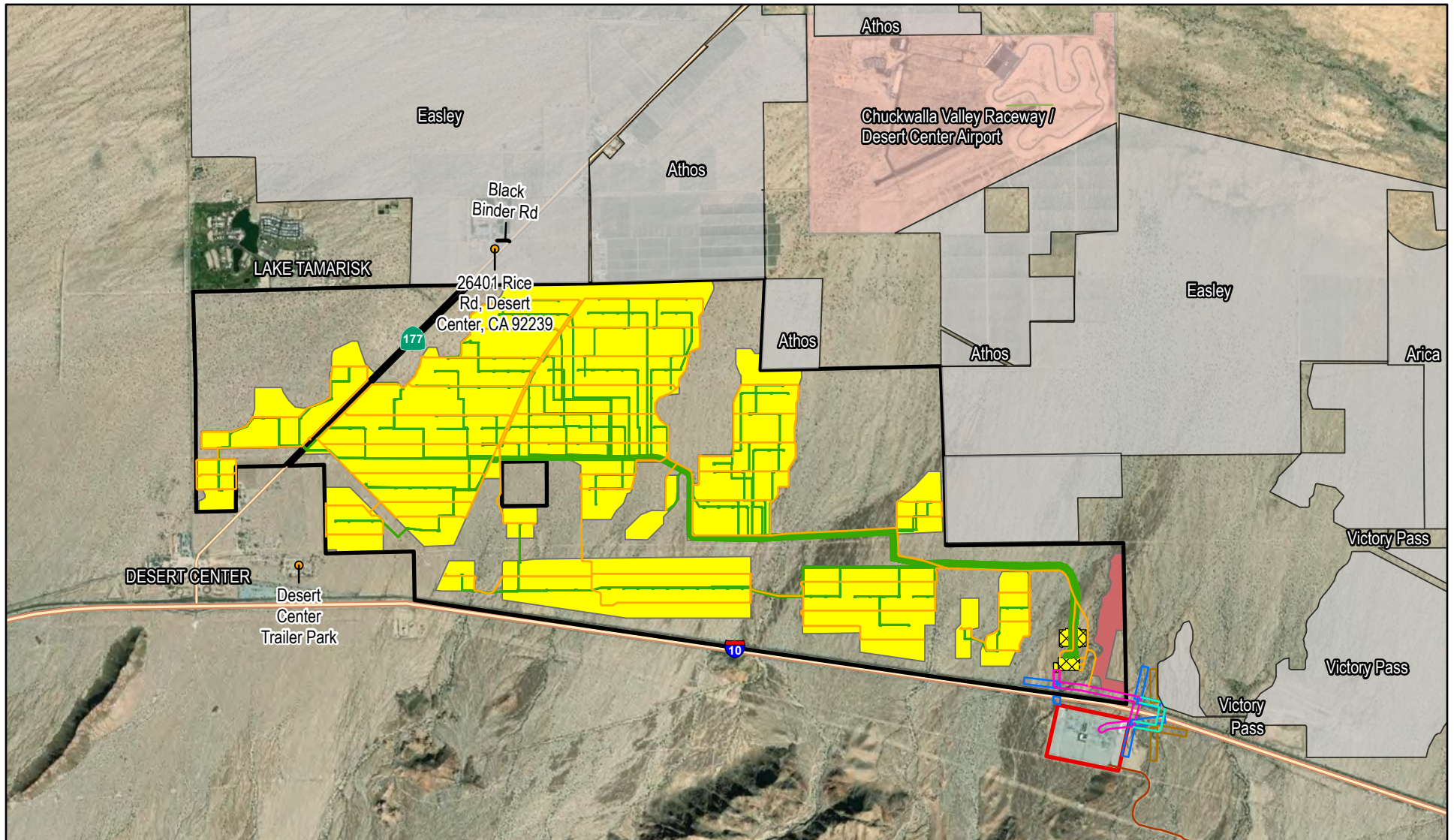

Figure 3.4-10

Wildlife Connectivity





- Nearest Sensitive Receptors
- Adjacent solar projects
- Chuckwalla Valley Raceway / Desert Center Airport
- Gen-tie Access Road
- 34.5 kV MVAC Lines

- 500-kV Gen-tie Line Option (based on final negotiations with SCE and ROW holders)
- Proposed 500-kV Gen-tie Line Corridor
- Pull Tensioning Area
- Optional Pull Tensioning Area
- Project Boundary

- Substation and BESS Area
- Eagle Crest Gen-tie Line
- Fenced Solar Array
- Existing SCE Red Bluff Substation
- Roads

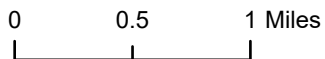
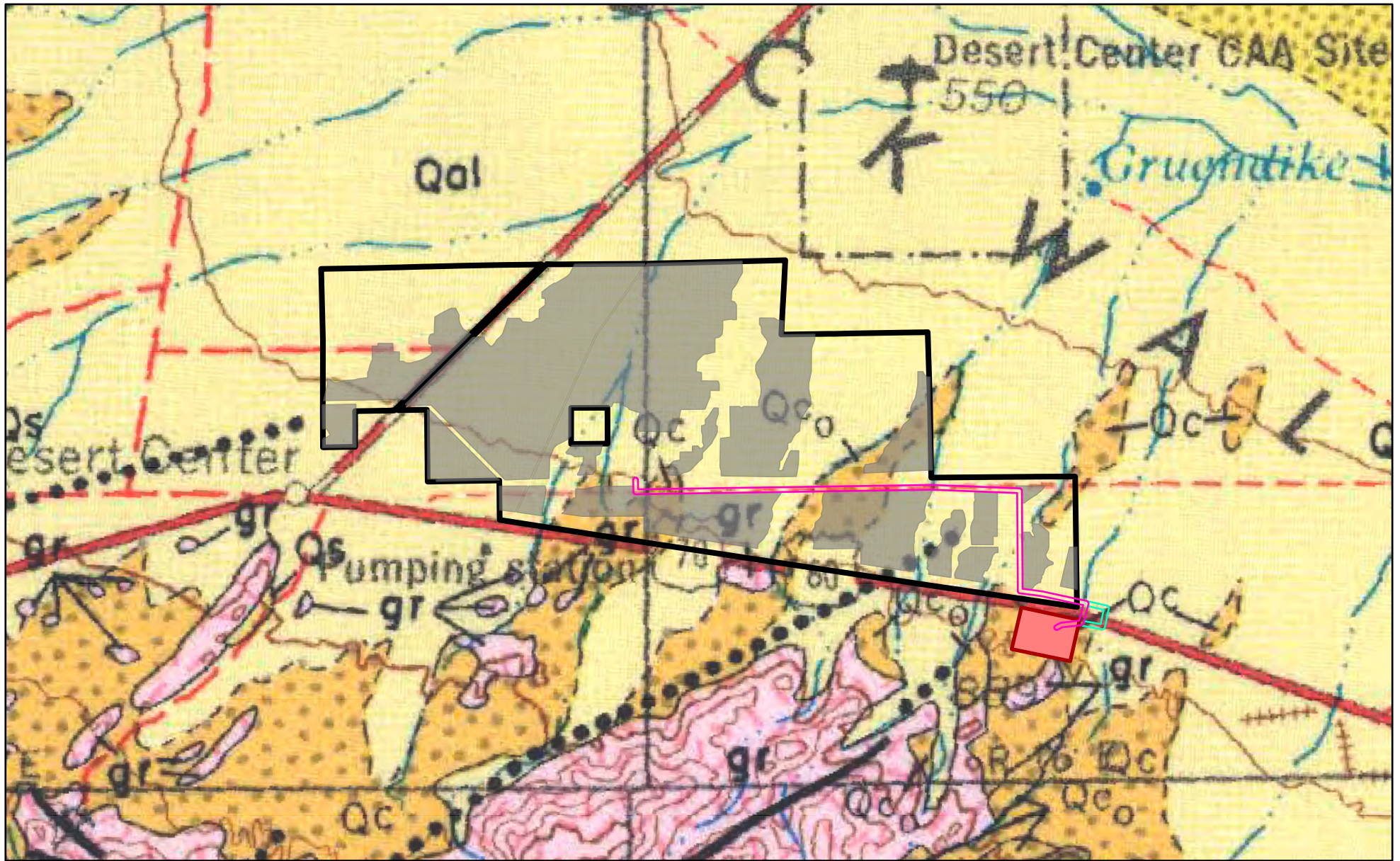

**Figure 3.12-1**

**Noise Sources and Sensitive Receptors**

Sources: Aspen, 2021; Intersect Power, 2021; Westwood, 2021; Esri, 2021.





Source: Jennings, 1967



0 0.5 1 Miles





-  Project Boundary
-  Proposed Development Areas
-  Proposed 500-kV Gen-tie Line Corridor
-  500-kV Gen-tie Line Corridor Option (based on final negotiations with SCE and ROW holders)
-  Existing Red Bluff Substation

Figure 3.13-1

Geologic Units: Jennings 1967



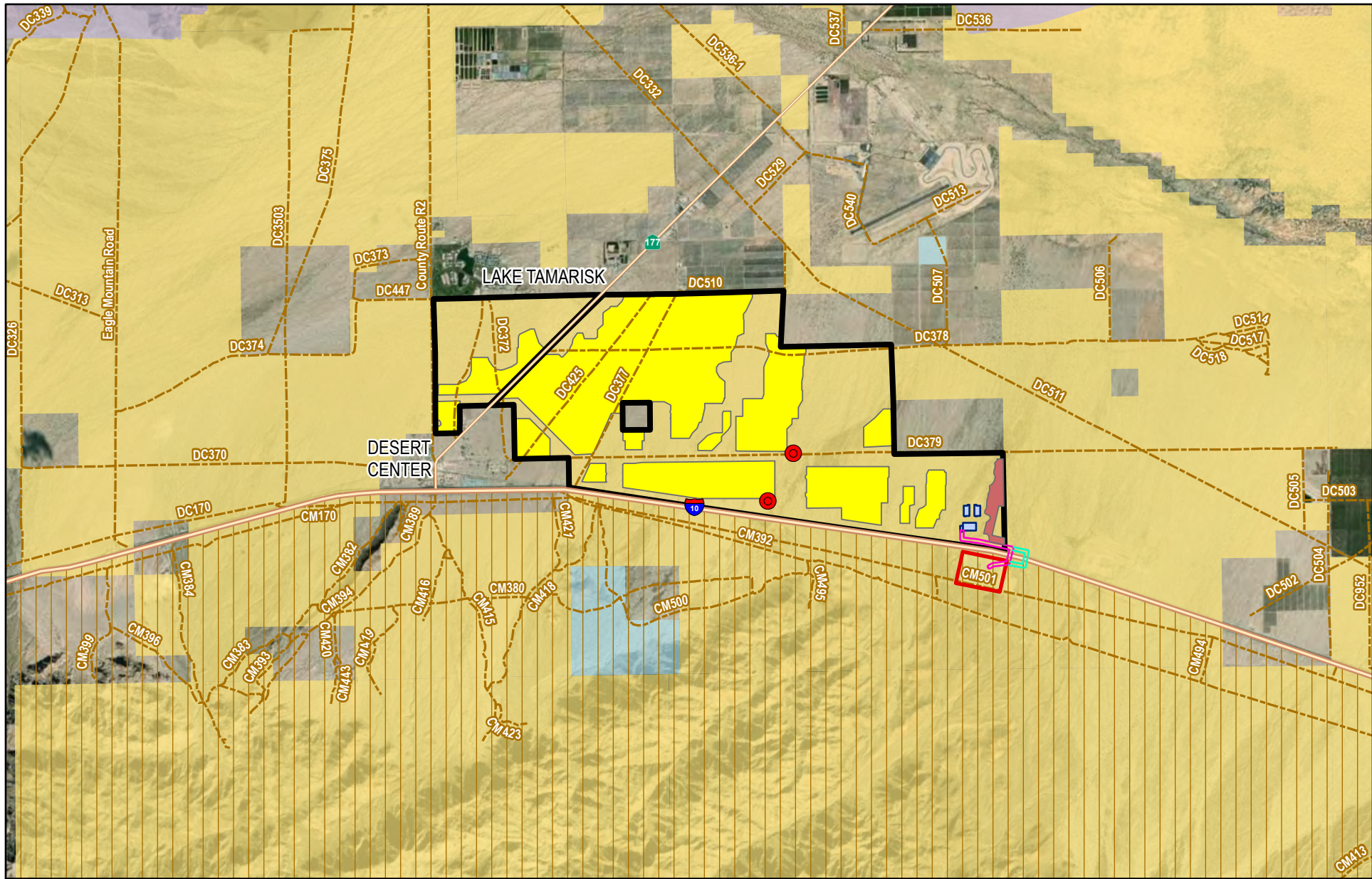

**—** Oberon Project Boundary

**■** Fenced Solar Array

**■** Eagle Crest Gen-tie Line

**—** Proposed 500-kV Gen-tie Line Corridor

**—** 500-kV Gen-tie Line Corridor Option (based on final negotiations with SCE and ROW holders)

**■** Proposed Substation and BESS Area

**■** Existing SCE Red Bluff Substation

**●** Modern Fire Ring

**—** BLM Open OHV Route

**■** Special Recreation Management Area

**■** Land Ownership

**■** Bureau of Land Management

**■** National Park Service

**■** State



0 0.5 1 Miles

**Figure 3.16-1**

**BLM OHV Routes**



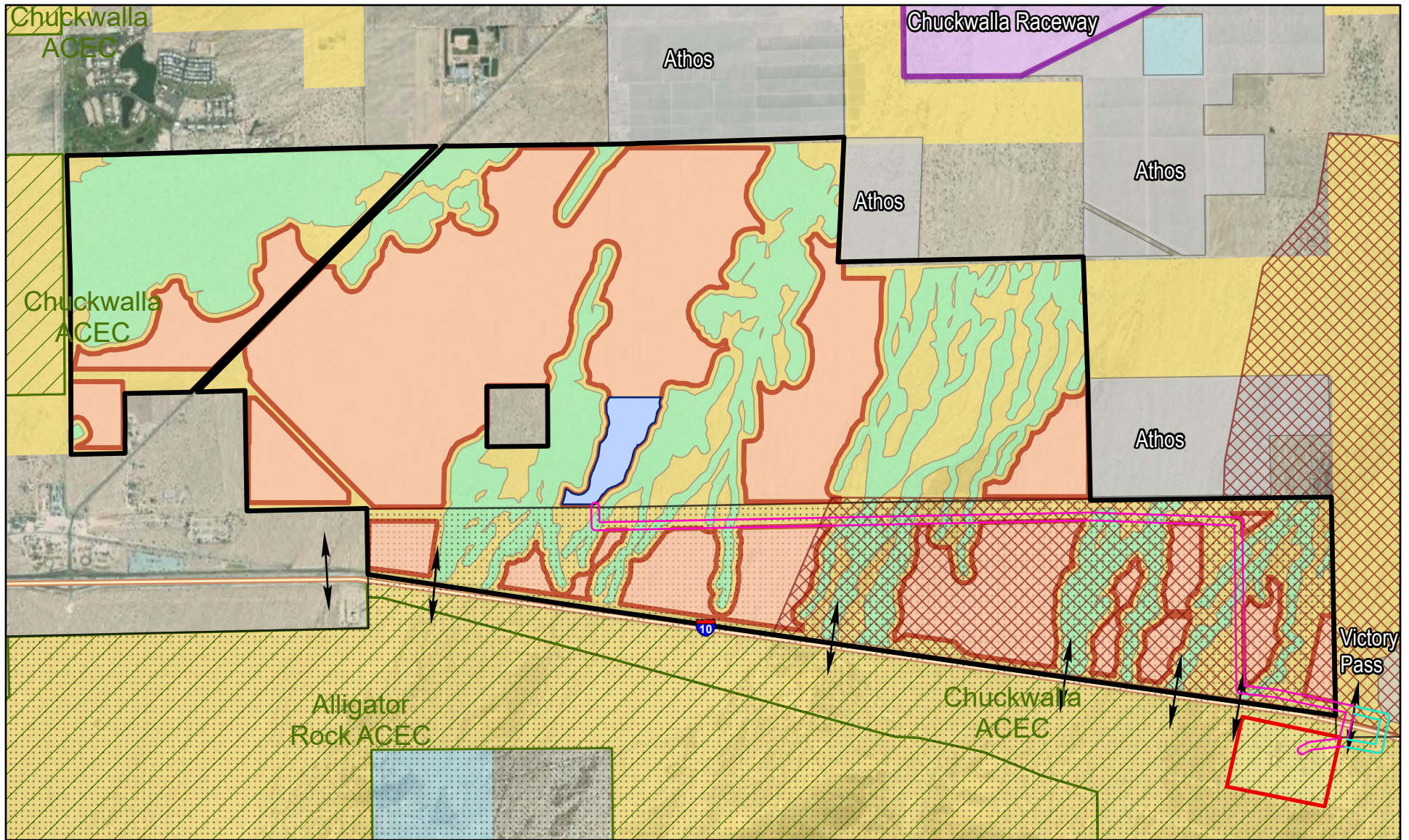

- |  |   |
|--|---|
| Project Area   | Area of Critical Environmental Concern (ACEC) |
| Adjacent Desert Center Solar Projects  | Freeway, Aqueduct, and Railway Underpasses    |
| Desert Tortoise Exclusion Fencing  | Multispecies Linkage                          |
| Proposed 500-kV Gen-Tie Line Corridor  | Chuckwalla Raceway                            |
| 500-kV Gen-tie Option (based on final negotiations with SCE and ROW holders) | Desert Tortoise Critical Habitat              |
| Alternative Substation and BESS Area   | <u>Land Ownership</u>                         |
| Existing SCE Red Bluff Substation  | Bureau of Land Management                     |
| Desert Dry Wash Woodland (200-foot Buffer) (Ironwood, 2020)                  | State   |

**Figure 4-1**  
**Land Use Plan Compliant Alternative**

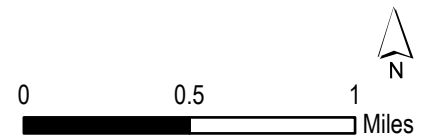



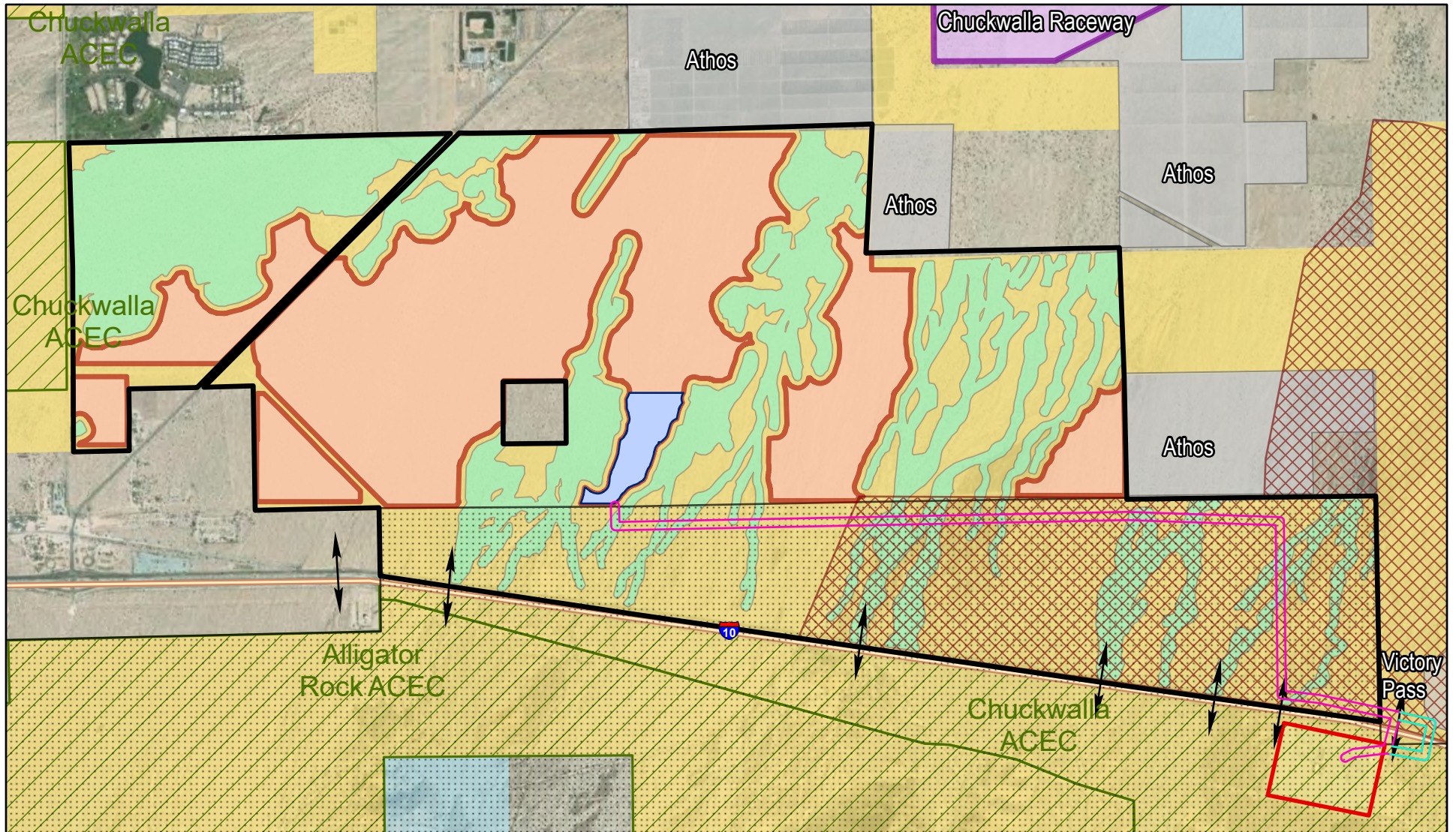

- |   |  |  |
|---|--|--|
| Project Area  | 500-kV Gen-tie Option (based on final negotiations with SCE and ROW holders) | Desert Tortoise Critical Habitat           |
| Adjacent Desert Center Solar Projects                       | Alternative Substation and BESS Area   | Freeway, Aqueduct, and Railway Underpasses |
| Resource Avoidance Alt. Fencing                             | Existing SCE Red Bluff Substation  | Chuckwalla Raceway                         |
| Desert Dry Wash Woodland (200-foot Buffer) (Ironwood, 2020) | Multispecies Linkage   | <u>Land Ownership</u>                      |
| Proposed 500-kV Gen-Tie Line Corridor                       | Area of Critical Environmental Concern (ACEC)                                | Bureau of Land Management                  |
|   |  | State                                      |

**Figure 4-2**  
**Resource Avoidance Alternative with**  
**Prehistoric Resources/TCR Option**

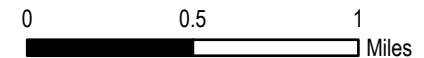

\* Tribal cultural resources avoided within solar panel fencing are not shown due to confidentiality agreements.